

# Connected Smart

e-CATALOG  
2024\_1.0

E N G L I S H

**ISEO**<sup>®</sup>  
ULTIMATE ACCESS TECHNOLOGIES



# **Connected** Smart

New

## 1NCA Smart Cable Free

An unlimited access control system.

These innovative readers Cable Free readers should be paired via Bluetooth® Low Energy 5.1 with the ISEO product of Smart Connected range to extend its opening possibilities, enhancing access credentials with numeric codes, RFID, or fingerprint scanning, depending on the model.

Powered by batteries, these wireless devices require no wiring and offer easy wall installation.



## Multiblindo Smart

Connectivity and monitoring.

ISEO's new motorized and self-locking lock is the perfect combination of ease of use and security in all situations. The sensors integrated into the lock provide constant monitoring of access and the door's status, which can be viewed on smartphones and tablets.





# ARGO App



Argo by ISEO

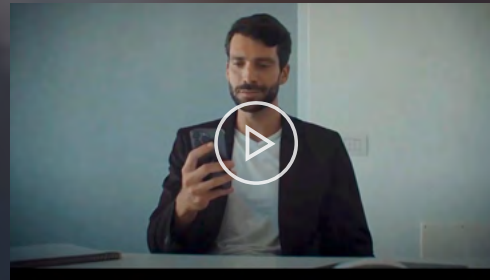

Open as you like. Even from remote.

Control smart devices of ISEO with the ARGO app.

Manage access to your spaces intuitively and securely, monitor activities in real time, and simplify permission management. With ARGO, you have total control by your side, wherever you are. Download it now and discover the future of security.

 [User manual ARGO Remote](#)

 [System brochure](#)



download



download



# Cybersecurity



ARGO is a reliable solution for access system security.

Cybersecurity in residential access control is crucial to ensure the safety of modern homes. For ISEO, security is very important. ISEO implements proven techniques based on industry best practices and derived from existing encryption and network security technologies. Thanks to direct connectivity to the locks and end-to-end encryption, without an intermediate server (the Cloud is only used as a bridge), Argo ensures both local and remote connections with the same level of security. Locally, the app connects to the opening device directly via Bluetooth Smart 5.0, ensuring maximum security with encryption techniques based on:

- Crypto AES 128.
- Session keys generated with ECDH (Elliptic-curve Diffie-Hellman).
- Random Number Generator according to NIST (National Institute of Standards and Technology) specifications.



## Sustainability



In ISEO's ARGO access control sustainability is a priority.

By implementing efficient energy solutions and recyclable materials, ARGO reduces its environmental impact. In addition, wireless installation and keyless operation ensure less use of materials that are not easily recyclable, such as metal keys and cables. ARGO represents a sustainable option for access security without compromising the environment.



Libra Smart electronic modular cylinder with RFID/Bluetooth reader and Standard mechanical knob.



# Argo system architecture

ISEO's cloud-connected wireless access control system is an advanced and versatile solution for managing doors and other types of access points, all facilitated by the absence of cabling thanks to the devices' on-board batteries and low energy technology. Thanks to cloud integration, the system offers secure and reliable connectivity, allowing real-time access to data and configurations. The system's scalability allows it to adapt to evolving needs, efficiently managing both small environments and larger buildings.

Up to 300 users per device

Unlimited number of devices and gateways per system

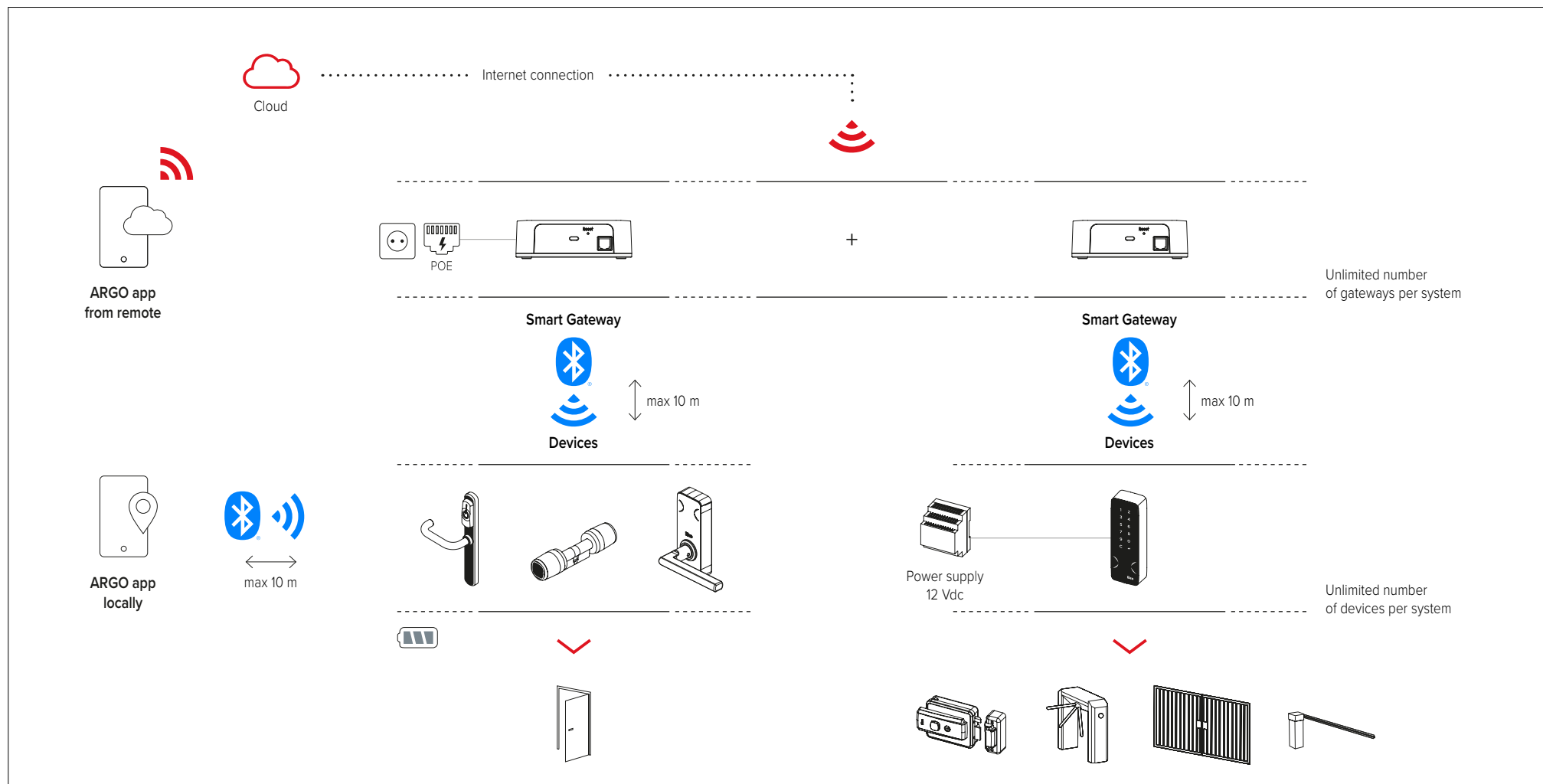

## Success Stories

### LAKE VILLA

---

Residential building, Henan, China

Residents of Lake Villa flats can open the doors of their homes in various ways: with their smartphone, a physical key or other credentials.

[Read more](#)

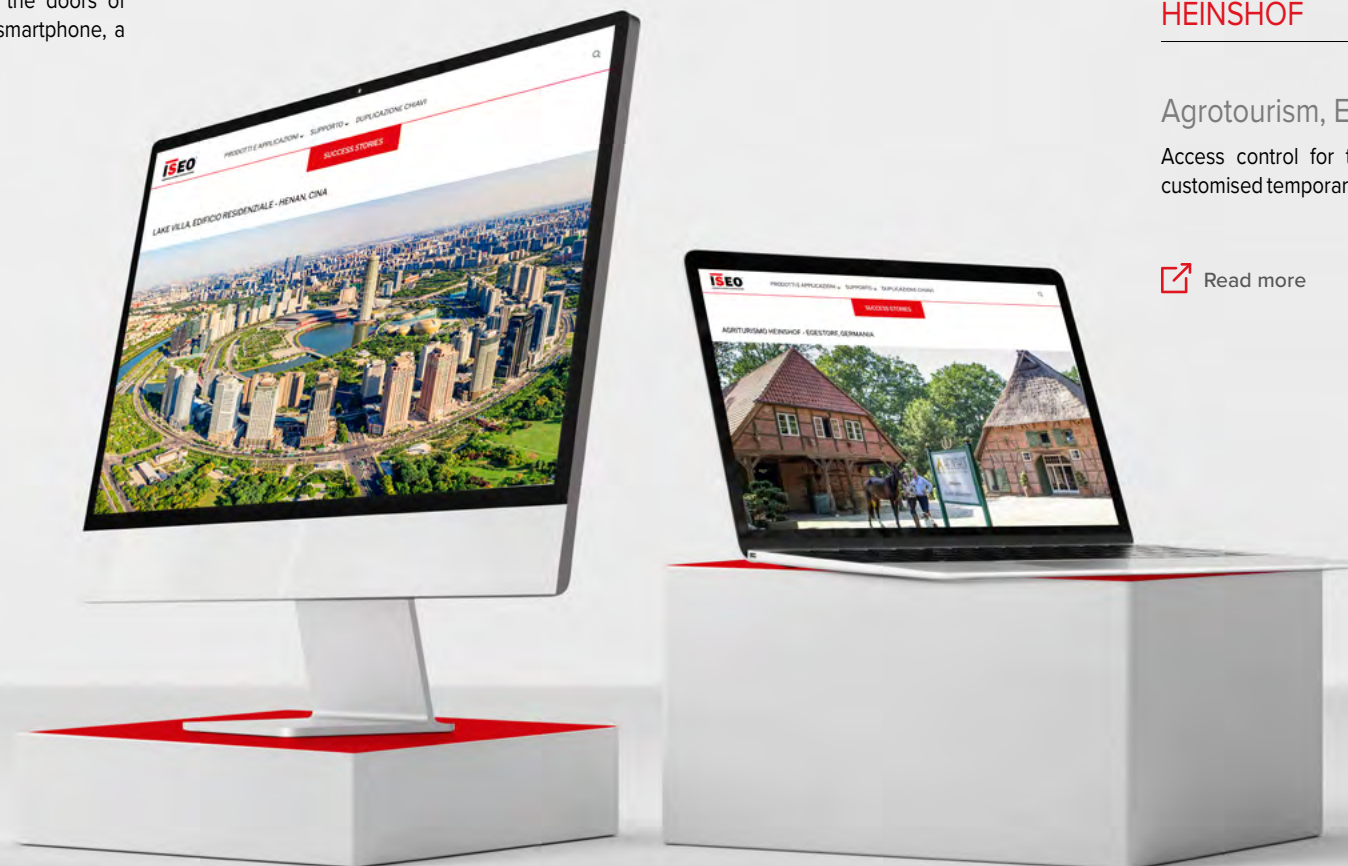

### HEINSHOF

---

Agrotourism, Egestorf, Germany

Access control for the hotel industry: how to send customised temporary access permits from any location.

[Read more](#)



# Reading Guide

Home Button and Previous View

Device name

Device type

Device code

If there is the

Code configurator

click to create the code using the configurator of the specific device

MAIATA | **1NCA** | Aries | Locker | Libra LE60 | Relay | Gateway | x1R

**1NCA Smart Mullion Relay**

CREDENTIAL READER RFID/BLUETOOTH®, WITH BUILT IN RELAY.

**Technical features**

**FIRMWARE**  
ARGO

**POWER UNIT**  
9÷24 Vdc (W)  
Automatic low power mode max 0,4mW  
Internal CR2032 3V Lithium battery for RTC (real time clock) backup

**STORAGE TEMPERATURE**  
-20°C ÷ +70°C

**PACKAGE**  
1 reader, 1 fixing bracket, Torx T8 key, 1 x Fixing bracket Torx screw (M2,5x5), Instruction manual, 2 x Screws (3,5x25 countersunk head) and wall plugs (5x25)

**ALERTS**  
- Led 3-colour series green, red, blue  
- Multi-frequency buzzer

**ACCESSORIES (NOT INCLUDED)**  
- Spacer with screws (cod. 00001S00354)

**MOUNTING**  
- Wall mounted

**ENVIRONMENTAL FEATURES**  
- IP66  
- H.R. max. 95% without condensing

**WORKING TEMPERATURE**  
-20°C ÷ +60°C

code **5E152415** Accessories

**DIMENSIONS**  
- Height: 146mm  
- Width: 48mm  
- Depth: 26mm

**ONLINE CONTENT**

- Web page
- Data sheet
- Leaflet
- User manual
- Installation guide
- Specifications

Quick navigation to devices' main pages

Technical Data of the device

Links to accessories pages

Links to online materials on [iseo.com](http://iseo.com)

Search by device

# MA1A Smart

Go to page



## The smart handle for many applications

MA1A Smart is the new electronic lock of the ISEO Connected products range which allows to manage the access with simplicity in residential, "light commercial" environments, B&B. MA1A with its compact and stylish design is an excellence of Made in Italy and represents the perfect retrofit solution for internal doors.

## Make your doors connected

MA1A Smart can be opened through Argo the smartphone app conceived for iOS and Android device, with which the user can manage, monitor and open all the doors upon which MA1A has been installed - RFID cards, tags, key fob. The installation of the smart handle is quickly and effortlessly, is easy to use and it is compatible with all DIN mechanical locks.

## Product's functions

- Memorize up to 300 users credentials
- Records the last 1000 events
- Battery-operated device with charge status detection
- Wake up by RFID card detection or phone Bluetooth® (patented)
- Low energy consumption device
- Real Time Clock/Calendar
- Light and acoustic signals
- Permanently open mode (office mode) without no extra battery consumption
- Block the Standard Users allowing access only to VIP users
- Programming and software updates by Argo app on iOS and Android devices

### FINISH

 Technopolymer

### COLOR

 Glossy black

### ENVIRONMENTAL CHARACTERISTICS

- IP54
- Max. 95% without condensing

### CREDENTIALS

- Badge
- Keyfob
- Bracelet
- Smartphone
- Apple Watch

### COMMUNICATION INTERFACE

- RFID ISO14443B/Mifare ISO14443A
- Bluetooth® Low Energy 5.1

### CERTIFICATIONS

- CE (Conformitee Europeenne)
- UKCA (UK Conformity Assessed)
- EN16867:2020 with classification I3I7I0IBI14IB/D\*OIOI
- EN1634-1 fire resistance EI90

\* B with Mifare Classic cards,  
D with Mifare DESFire cards

## MODELS

→ Standard

p. 13

# MA1A Smart

## Selection guide

The MA1A electronic handle is available with different handle sets.

The items required to adapt the different door types and to ensure correct installation are various and must be chosen from the options available according to the characteristics and the dimensions of the door and the specific usage requirements.

To ensure the correctness and completeness of the order below is a guide for the selection of the various articles that make up the set for each door.

## ORDER THE PRODUCT IN A FEW STEPS

**1**

**Check the type of door** on which the MA1A Connected Smart Handle will be mounted.

**3**

**Compose the necessary spindle and screws kit.**

**2**

**Choose the handle set** you prefer.

**4**

**Optional.**  
Choose **lock to match**.

[Go to page](#)

[Go to page](#)

[Go to page](#)

[Go to page](#)

[SELECTION GUIDE](#)

## MODELS

→ [Standard](#)

[p. 13](#)

## MA1A Smart Standard

### CONNECTED SMART HANDLE WITH RFID TECHNOLOGY AND BLUETOOTH®

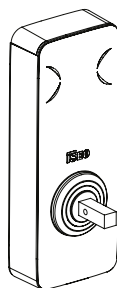

### Technical features

#### FIRMWARE

ARGO

#### POWER UNIT

3 alkaline batteries 1.5V type AAA

#### ESTIMATED BATTERY LIFE

Up to 2 years, up to 20.000 opening. The figure is dependent on the mode and environment of use and the options activated.

#### ALERTS

- Led 3-colour series green, red, blue
- Multi-frequency buzzer

#### PRODUCT COMPATIBILITY

- Backset min 35 mm (E)
- Escutcheon max diameter = 52mm (C)
- Min center-holes distance = 70mm (D)
- DIN holes = 38mm (DIN)
- Multiblindo Easy Exit Lateral compatible version (M)
- Max handle rotation angle 40°
- 7, 8 or 9 mm square spindle (\*)
- Recommended locks with latchbolt only or automatic deadbolt function
- Max door mass and dimensions 250 Kg, 1320 x 2520 mm (W x H)
- Door thickness 40 - 125 mm

(\*) 8mm square spindle required with MA1A handles provided by ISEO. 7 and 9mm square spindle compatible to MA1A available (go to Aries screws and handle follower kit).  
Compatible to all European DIN locks

#### MOUNTING

- On door

#### ENVIRONMENTAL FEATURES

- IP54
- H.R. max. 95% without condensing

#### WORKING TEMPERATURE

-20°C ÷ +60°C

#### STORAGE TEMPERATURE

-20°C ÷ +70°C

#### PACKAGE

MA1A smart handle, 3x AAA 1,5Vdc alkaline batteries, torx key T8, anti-tilt kit.

#### ACCESSORIES (NOT INCLUDED)

- Handle Set (standard and with Safe-Touch antibacterial protection)
- Spindle and screws kit

code 00E40201555



#### DIMENSIONS

- Width: 56mm
- Length: 147mm
- Thickness: 24mm
- Handle length: 115 mm from the center of the plate

Weight  
600 g

#### ONLINE CONTENT

 Web page

 Data sheet

 Leaflet

 User manual

 Installation guide

 Specifications

 Custom Handle Specifications

 Drilling Template

# MA1A Smart

## Accessories

### HANDLE SET

#### YUMA

##### MA1A Handle Set

Package: 1 MA1A external handle, 1 Internal handle, 1 Internal handle fixing plate with reinforcing spring and cover, 2 Internal and external cylinder escutcheons with covers.

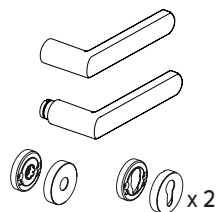

Zamak Alloy – Matte Black RAL 9005

1 00.329.005

#### WITH SAFE TOUCH ANTIBACTERIAL PROTECTION

Safe Touch treatment applied to external and internal handle.

1 00.329.005A



Zamak Alloy – Satin Chrome

1 00.329.00Y

#### WITH SAFE TOUCH ANTIBACTERIAL PROTECTION

Safe Touch treatment applied to external and internal handles.

1 00.329.00YA



#### URACAN

##### MA1A Handle Set

Package: 1 MA1A external handle, 1 Internal handle, 1 Internal handle fixing plate with reinforcing spring and cover, 2 Internal and external cylinder escutcheons with covers.

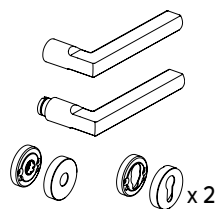

Stainless steel – Matte Black RAL 9005

1 00.431.005

#### WITH SAFE TOUCH ANTIBACTERIAL PROTECTION

Safe Touch treatment applied to external and internal handles.

1 00.431.005A



Satin Stainless steel

1 00.431.002

#### WITH SAFE TOUCH ANTIBACTERIAL PROTECTION

Safe Touch treatment applied to external and internal handles.

1 00.431.002A

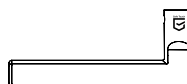

# MA1A Smart

## Accessories

### SPINDLE AND SCREWS KIT

Spindle and screws length related to door thickness (A)  
 Package includes: 1 square spindle, 2 M5 fixing screws with thread-locking.  
 NOTE: select the right kit depending on door thickness.

#### 8 mm square spindle \* and 2xM5 screws kit

Door thickness from 40 to 50 mm	1	201E004050A
Door thickness from 50 to 60 mm	1	201E005060A
Door thickness from 60 to 70 mm	1	201E006070A
Door thickness from 70 to 80 mm	1	201E007080A
Door thickness from 80 to max 125 mm (to be cut)	1	201E008010A

\* For 7 and 9mm square spindles, refer to Aries screws and handle follower kit chapter.

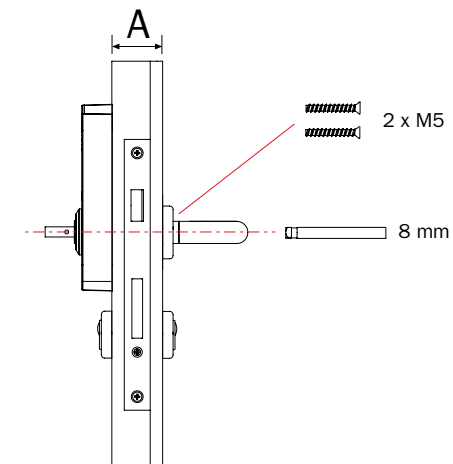

### LOCK (CAN BE COMBINED)

#### AUTOMATIC MECHANICAL LOCK

Mortise lock, automatic deadbolt function (18 mm extension)  
 Panic exit function, splitted latchbolt, equipped with devices against forced entry (reversible).  
 Backset: 55 mm, center distance: 85 mm, 8 mm handle follower  
 Chrome plated, squared/rounded frontplate.  
 Package: 1 lock, 1 striking plate.

Squared frontplate	1	207553.Z
Rounded frontplate	1	217553.Z

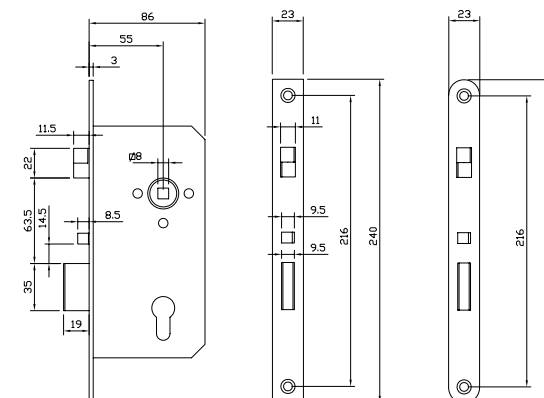

# 1NCA Smart



## A new range of multistandard readers

1NCA Smart Readers is an innovative range of multi-standard, wall-mounted and weatherproof readers of ISEO Connected products line, designed for access management in residential and light commercial buildings. These readers can be easily installed and can manage internal doors but also outdoor gates since they have the IP66 certification.

## Elegant in every situation

All 1NCA readers combine sleek and minimalist design with premium and durable materials, which is well suited to different environments. Experience the perfect blend of elegance and reliability, elevating your security measures to new heights and unlocking your freedom to move.

### FINISH

- Technopolymer
- Glass

### COLOR

- Glossy black

## Product's functions

- Memorize up to 300 users credentials
- Records the last 1000 events
- Wake up by RFID card detection or phone Bluetooth® (patented)
- Low energy consumption device
- Real Time Clock/Calendar
- Light and acoustic signals
- Permanently open mode (office mode) without no extra battery consumption
- Block the Standard Users allowing access only to VIP users
- Programming and software updates by Argo app on iOS and Android devices

Go to page

### MODELS

- Mullion Lockbus p. 18
- Mullion Relay p. 19
- Mullion 485 p. 20
- Mullion Keyboard Lockbus p. 21
- Mullion Keyboard Relay p. 22
- Mullion Keyboard 485 p. 23
- Cable Free RFID p. 24
- Cable Free Keyboard p. 25
- Cable Free Finger p. 26

### ENVIRONMENTAL CHARACTERISTICS

- IP66
- Max. 95% without condensing

### CREDENTIALS

- Badge
- Keyfob
- Bracelet
- Smartphone
- Apple Watch

### COMMUNICATION INTERFACE

- RFID ISO14443B/Mifare ISO14443A
- Bluetooth® Low Energy 5.1

### CERTIFICATIONS

- Compliance to RED, European and UK directives concerning radio equipment regulations



# 1NCA Smart

## Selection guide

1NCA Smart readers are ISEO's new credential readers characterised by an elegant and contemporary design suitable for outdoor installation (IP66). They are available in various models to meet different installation and functional requirements.

### ORDER THE PRODUCT IN A FEW STEPS

1

Choose the 1NCA Connected Smart Reader model suitable for your application and click in the column on the right :

#### Mullion Relay and Mullion Keyboard Relay

Devices with onboard relays for operating directly on electromechanical gates.

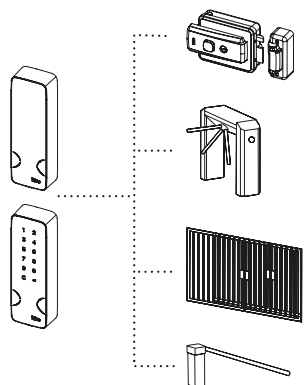

#### Mullion Lockbus and Mullion Keyboard Lockbus

Lockbus devices for operating electromechanical gates in combination with the Actuator for electromechanical locks. Suitable for replacing the ISEO's Stylos Smart reader.

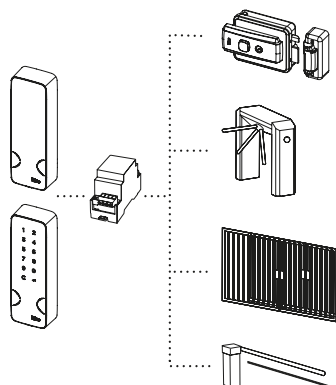

#### Mullion 485 and Mullion Keyboard 485

RS485 devices for operating doors with ISEO Multiblindo SMART locks (PWW and PWW+R configurations).

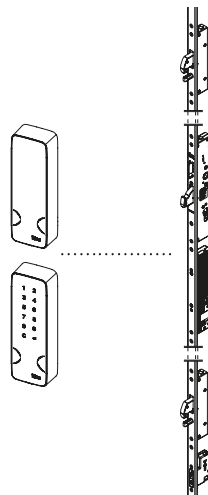

#### Cable Free RFID, Keyboard and Finger

Battery-powered devices that can be paired via Bluetooth to any ISEO Connected Smart device (Libra LE60, Aries, MA1A, Relay..), in order to increase their usable credentials.

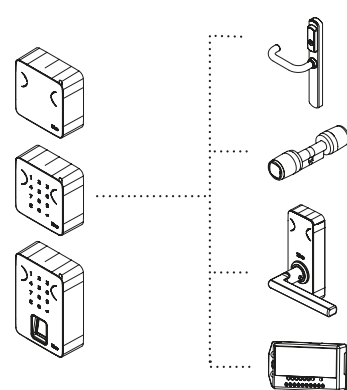

2

#### Optional.

Choose accessories to complete the system.

Go to page

### SELECTION GUIDE

#### MODELS

- Mullion Lockbus p. 18
- Mullion Relay p. 19
- Mullion 485 p. 20
- Mullion Keyboard Lockbus p. 21
- Mullion Keyboard Relay p. 22
- Mullion Keyboard 485 p. 23
- Cable Free RFID p. 24
- Cable Free Keyboard p. 25
- Cable Free Finger p. 26

## 1NCA Smart Mullion Lockbus

### CREDENTIAL READER RFID/BLUETOOTH®, WITH LOCKBUS CONNECTION

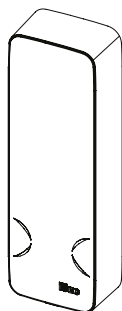

### Technical features

**FIRMWARE**  
ARGO

**POWER UNIT**  
9÷24 Vdc (1W)  
Automatic low power mode max 0,4mW  
Internal CR2032 3V Lithium battery for RTC (real time clock) backup

**ALERTS**  
- Led 3-colour series green, red, blue  
- Multi-frequency buzzer

**PRODUCT COMPATIBILITY**  
- Device with Lockbus interface. Suitable as a replacement of Stylos Smart, to couple with the electric lock actuator (5E2501)

**MOUNTING**  
- Wall mounted

**ENVIRONMENTAL FEATURES**  
- IP66  
- H.R. max. 95% without condensing

**WORKING TEMPERATURE**  
-20°C ÷ +60°C

**STORAGE TEMPERATURE**  
-20°C ÷ +70°C

**PACKAGE**  
1 reader, 1 fixing bracket, Torx T8 key, 1 x Fixing bracket Torx screw (M2,5x5), instruction manual,  
2 x Screws (3,5x25 countersunk head) and wall plugs (5x25),  
Spacer with screws included (cod. 0000IS00354 )

**ACCESSORIES (NOT INCLUDED)**  
- Electric lock actuator (cod. 5E2501)

code 5E152315



#### DIMENSIONS

- Height: 146mm
- Width: 48mm
- Depth: 26mm

#### ONLINE CONTENT

-  Web page
-  Data sheet
-  Leaflet
-  User manual
-  Installation guide
-  Specifications

## 1NCA Smart Mullion Relay

CREDENTIAL READER RFID/BLUETOOTH®,  
WITH BUILT IN RELAY.

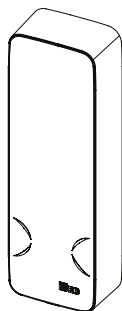

### Technical features

**FIRMWARE**  
ARGO

**POWER UNIT**  
9÷24 Vdc (1W)  
Automatic low power mode max 0,4mW  
Internal CR2032 3V Lithium battery for RTC (real time clock) backup

**ALERTS**  
- Led 3-colour series green, red, blue  
- Multi-frequency buzzer

**MOUNTING**  
- Wall mounted

**ENVIRONMENTAL FEATURES**  
- IP66  
- H.R. max. 95% without condensing

**WORKING TEMPERATURE**  
-20°C ÷ +60°C

**STORAGE TEMPERATURE**  
-20°C ÷ +70°C

**PACKAGE**  
1 reader, 1 fixing bracket, Torx T8 key, 1 x Fixing bracket Torx screw (M2,5x5), instruction manual,  
2 x Screws (3,5x25 countersunk head) and wall plugs (5x25)

**ACCESSORIES (NOT INCLUDED)**  
- Spacer with screws (cod. 0000IS00354)

code 5E152415



### DIMENSIONS

- Height: 146mm
- Width: 48mm
- Depth: 26mm

### ONLINE CONTENT

-  Web page
-  Data sheet
-  Leaflet
-  User manual
-  Installation guide
-  Specifications

## 1NCA Smart Mullion 485

CREDENTIAL READER RFID/BLUETOOTH®,  
WITH RS485 CONNECTION

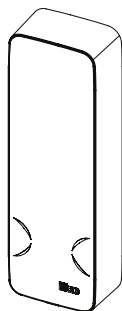

### Technical features

**FIRMWARE**  
ARGO

**POWER UNIT**  
9÷24 Vdc (1W)  
Automatic low power mode max 0,4mW  
Internal CR2032 3V Lithium battery for RTC (real time clock) backup

**ALERTS**  
- Led 3-colour series green, red, blue  
- Multi-frequency buzzer

**PRODUCT COMPATIBILITY**  
- Device with RS485 interface. This reader can be used in the PWW and PWW+R configurations of the Multiblindo Smart lock.

**MOUNTING**  
- Wall mounted

**ENVIRONMENTAL FEATURES**  
- IP66  
- H.R. max. 95% without condensing

**WORKING TEMPERATURE**  
-20°C ÷ +60°C

**STORAGE TEMPERATURE**  
-20°C ÷ +70°C

**PACKAGE**  
1 reader, 1 fixing bracket, Torx T8 key, 1 x Fixing bracket Torx screw (M2,5x5), instruction manual,  
2 x Screws (3,5x25 countersunk head) and wall plugs (5x25)

**ACCESSORIES (NOT INCLUDED)**  
- Spacer with screws (cod. 0000IS00354)  
- Power supply 24Vdc 1.5 A power supply (cod. 5E3506)

code 5E152215



**DIMENSIONS**  
- Height: 146mm  
- Width: 48mm  
- Depth: 26mm

### ONLINE CONTENT

 Web page

 Data sheet

 Leaflet

 User manual

 Specifications

## 1NCA Smart Mullion Keyboard Lockbus

CREDENTIAL READER WITH KEYBOARD, RFID CONTACTLESS MULTISTANDARD, BLUETOOTH® WITH LOCKBUS CONNECTION.

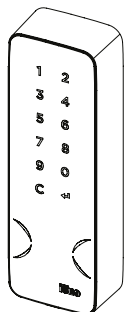

### Technical features

**FIRMWARE**  
ARGO

**POWER UNIT**  
9÷24 Vdc (1W)  
Automatic low power mode max 0,4mW  
Internal CR2032 3V Lithium battery for RTC (real time clock) backup

**ALERTS**  
- Led 3-colour series green, red, blue  
- Multi-frequency buzzer

**PRODUCT COMPATIBILITY**  
- Device with Lockbus interface. Suitable as a replacement of Stylos Smart, to couple with the electric lock actuator (5E2501)

**MOUNTING**  
- Wall mounted

**ENVIRONMENTAL FEATURES**  
- IP66  
- H.R. max. 95% without condensing

**WORKING TEMPERATURE**  
-20°C ÷ +70°C

**STORAGE TEMPERATURE**  
-25°C ÷ +75°C

**PACKAGE**  
1 reader, 1 fixing bracket, Torx T8 key, 1 x Fixing bracket Torx screw (M2,5x5), instruction manual, 2 x Screws (3,5x25 countersunk head) and wall plugs (5x25), spacer with screws (cod. 0000IS00354 )

**ACCESSORIES (NOT INCLUDED)**  
- Electric lock actuator (cod. 5E2501)

code 5E152325



#### DIMENSIONS

- Height: 146mm
- Width: 48mm
- Depth: 26mm

#### ONLINE CONTENT

-  Web page
-  Data sheet
-  Leaflet
-  User manual
-  Installation guide
-  Specifications

## INCA Smart Mullion Keyboard Relay

CREDENTIAL READER WITH KEYBOARD, RFID CONTACTLESS MULTISTANDARD, BLUETOOTH®, WITH BUILT IN RELAY.

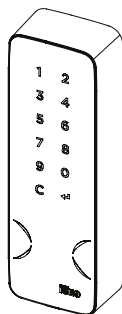

### Technical features

**FIRMWARE**  
ARGO

**POWER UNIT**  
9÷24 Vdc (1W)  
Automatic low power mode max 0,4mW  
Internal CR2032 3V Lithium battery for RTC (real time clock) backup

**ALERTS**  
- Led 3-colour series green, red, blue  
- Multi-frequency buzzer

**MOUNTING**  
- Wall mounted

**ENVIRONMENTAL FEATURES**  
- IP66  
- H.R. max. 95% without condensing

**WORKING TEMPERATURE**  
-20°C ÷ +70°C

**STORAGE TEMPERATURE**  
-25°C ÷ +75°C

**PACKAGE**  
1 reader, 1fixing bracket, Torx T8 key, 1 x Fixing bracket Torx screw (M2,5x5), instruction manual,  
2 x Screws (3,5x25 countersunk head) and wall plugs (5x25).

**ACCESSORIES (NOT INCLUDED)**  
- Spacer with screws (cod. 0000IS00354)



code **5E152425**

 Accessories

#### DIMENSIONS

- Height: 146mm
- Width: 48mm
- Depth: 26mm

#### ONLINE CONTENT

-  Web page
-  Data sheet
-  Leaflet
-  User manual
-  Installation guide
-  Specifications

## INCA Smart Mullion Keyboard 485

CREDENTIAL READER RFID/BLUETOOTH®  
WITH KEYBOARD, WITH RS485 CONNECTION

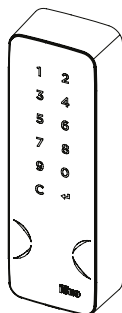

### Technical features

**FIRMWARE**  
ARGO

**POWER UNIT**  
9÷24 Vdc (1W)  
Automatic low power mode max 0,4mW  
Internal CR2032 3V Lithium battery for RTC (real time clock) backup

**ALERTS**  
- Led 3-colour series green, red, blue  
- Multi-frequency buzzer

**PRODUCT COMPATIBILITY**  
- Device with RS485 interface. This reader can be used in the PWW and PWW+R configurations of the Multiblindo Smart lock.

**MOUNTING**  
- Wall mounted

**ENVIRONMENTAL FEATURES**  
- IP66  
- H.R. max. 95% without condensing

**WORKING TEMPERATURE**  
-20°C ÷ +60°C

**STORAGE TEMPERATURE**  
-20°C ÷ +70°C

**PACKAGE**  
1 reader, 1 fixing bracket, Torx T8 key, 1 x Fixing bracket Torx screw (M2,5x5), instruction manual,  
2 x Screws (3,5x25 countersunk head) and wall plugs (5x25)

**ACCESSORIES (NOT INCLUDED)**  
- Spacer with screws (cod. 0000IS00354)  
- Power supply 24Vdc 1.5 A power supply (cod. 5E3506)

code **5E152225**

 Accessories

### DIMENSIONS

- Height: 146mm  
- Width: 48mm  
- Depth: 26mm

### ONLINE CONTENT

 Web page

 Data sheet

 Leaflet

 User manual

 Specifications

## 1NCA Smart Cable Free RFID

CABLE FREE RFID AND BLUETOOTH®, BATTERY OPERATED, CAN BE COUPLED TO ANY ISEO CONNECTED SMART LOCKING DEVICE

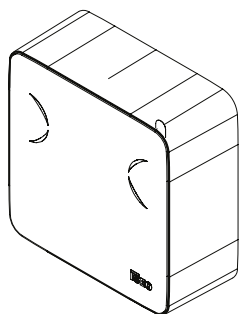

### Technical features

**FIRMWARE**  
ARGO

**POWER UNIT**  
4 Alkaline AA batteries  
Max Power consumption 1W  
Automatic low power mode max 0,4mW

**ALERTS**  
- Led 3-colour series green, red, blue  
- Multi-frequency buzzer

**MOUNTING**  
- Wall mounted

**ENVIRONMENTAL FEATURES**  
- IP66  
- H.R. max. 95% without condensing

**WORKING TEMPERATURE**  
-20°C ÷ +60°C

**STORAGE TEMPERATURE**  
-20°C ÷ +70°C

**PACKAGE**  
1 reader, 4 Alkaline AA batteries, 1 fixing bracket, Torx T8 key, 1 x Fixing bracket Torx screw (M2,5x5), instruction manual, 2 x Screws (3,5x25 countersunk head) and wall plugs (5x25).

code **5E1511155**

**DIMENSIONS**  
- Height: 82mm  
- Width: 82mm  
- Depth: 26mm

### ONLINE CONTENT

- |  |  |
|--|--|
|  Web page   |  User manual        |
|  Data sheet |  Installation guide |
|  Leaflet    |  Specifications     |



## 1NCA Smart Cable Free Keyboard

CABLE FREE RFID AND BLUETOOTH® READER, BATTERY OPERATED, FEATURING A CAPACITIVE NUMERIC KEYBOARD, CAN BE COUPLED TO ANY ISEO CONNECTED SMART LOCKING DEVICE

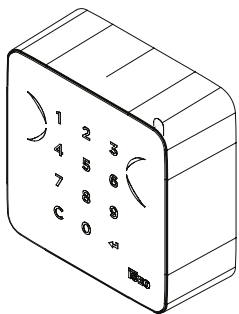

### Technical features

**FIRMWARE**  
ARGO

**POWER UNIT**  
4 Alkaline AA batteries  
Max Power consumption 1W  
Automatic low power mode max 0,4mW

**ALERTS**  
- Led 3-colour series green, red, blue  
- Multi-frequency buzzer

**MOUNTING**  
- Wall mounted

**ENVIRONMENTAL FEATURES**  
- IP66  
- H.R. max. 95% without condensing

**WORKING TEMPERATURE**  
-20°C ÷ +60°C

**STORAGE TEMPERATURE**  
-25°C ÷ +70°C

**PACKAGE**  
1 reader, 4 Alkaline AA batteries, 1 fixing bracket, Torx T8 key, 1 x Fixing bracket Torx screw (M2,5x5), instruction manual, 2 x Screws (3,5x25 countersunk head) and wall plugs (5x25).

code 5E1511255

**DIMENSIONS**  
- Height: 82mm  
- Width: 82mm  
- Depth: 26mm

### ONLINE CONTENT

- |  |  |
|--|--|
|  Web page   |  User manual        |
|  Data sheet |  Installation guide |
|  Leaflet    |  Specifications     |

## 1NCA Smart Cable Free Finger

CABLE FREE RFID AND BLUETOOTH® READER, BATTERY OPERATED, FEATURING A CAPACITIVE NUMERIC KEYBOARD AND A FINGERPRINT READER, CAN BE COUPLED TO ANY ISEO CONNECTED SMART LOCKING DEVICE

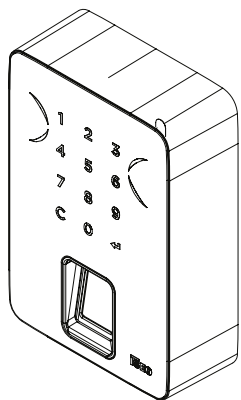

code 5E1511355

### DIMENSIONS

- Height: 120mm
- Width: 82mm
- Depth: 35mm

### Technical features

**FIRMWARE**  
ARGO

**POWER UNIT**  
4 Alkaline AA batteries  
Max Power consumption 1W  
Automatic low power mode max 0,4mW

**ALERTS**  
- Led 3-colour series green, red, blue  
- Multi-frequency buzzer

**MOUNTING**  
- Wall mounted

**ENVIRONMENTAL FEATURES**  
- IP66  
- H.R. max. 95% without condensing

**WORKING TEMPERATURE**  
-20°C ÷ +60°C

**STORAGE TEMPERATURE**  
-25°C ÷ +70°C

**PACKAGE**  
1 reader, 4 Alkaline AA batteries, 1 fixing bracket, Torx T8 key, 1 x Fixing bracket Torx screw (M2,5x5), instruction manual, 2 x Screws (3,5x25 countersunk head) and wall plugs (5x25).

### ONLINE CONTENT

- |  |  |
|--|--|
|  Web page   |  User manual        |
|  Data sheet |  Installation guide |
|  Leaflet    |  Specifications     |

# 1NCA Smart

## Accessories

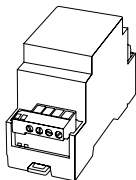

### ELECTRIC LOCK ACTUATOR

1 relay + 1 booster.  
 3 inputs (1 digital, 1 analog, 1 digital/ analog)  
 Lockbus interface.  
 8-30Vdc Power Supply  
 DIN35 rail mounting.  
 Package: 1 actuator, instruction manual.

1 5E2501

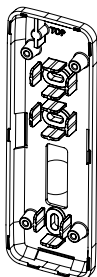

### SPACER WITH SCREWS (FOR MULLION READER)

2 x Screws (3,5x25 flat-head)  
 4 x Screws (3x8)

1 0000IS00354

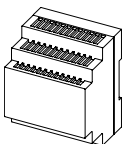

### POWER SUPPLY UNIT 24Vdc - 70W

Input 120-230Vac. Output 24Vdc 1,5A.  
 DIN35 rail mounting.

Package: 1 Power Supply, instruction manual

1 5E3506

# Aries Smart 2.0

Go to page



## Make your door Smart

The installation flexibility and simplicity make it the perfect solution for community and residential access control (shopping malls, industries, public and private offices, schools and universities, hospitals and retired hostels, residences and hotels, etc.).

## For many applications

ARIES electronic trim set can be fit on most doors. It is conceived to be used also with the majority of mechanical locks, for the utmost installation flexibility. The battery operation and cableless technology makes ARIES the perfect solution for access management, ensuring utmost flexibility and low installation costs both on new and existing doors.

## FINISH

Stainless

## Product's functions

- Handle movement detection.
- Emergency mechanical key detection.
- Privacy signal.
- Memorize up to 300 users credentials
- Records the last 1000 events
- Battery-operated device with charge status detection
- Wake up by RFID card detection or phone Bluetooth® (patented)
- Low energy consumption device
- Real Time Clock/Calendar
- Light and acoustic signals
- Permanently open mode (office mode) without no extra battery consumption
- Block the Standard Users allowing access only to VIP users
- Programming and software updates by Argo app on iOS and Android devices

## MODELS

- Standard p. 30
- For panic devices p. 31
- For custom handles p. 32
- For custom handles for panic devices p. 33
- For DIN lock p. 34
- For fire locks p. 35
- For Premi Apri Meroni locks p. 36

## ENVIRONMENTAL CHARACTERISTICS

- IP55
- IP54

## CREDENTIALS

- Badge
- Keyfob
- Bracelet
- Smartphone
- Apple Watch

## COMMUNICATION INTERFACE

- RFID ISO14443B/Mifare ISO14443A
- Bluetooth® Low Energy 5.1

## CERTIFICATIONS

- EN179 certification available in combination with specific locks
- EN125 certification available in combination with specific panic devices and locks

# Aries Smart 2.0

## Selection guide

The ARIES electronic handle is available in different versions to suit the costumers' needs and the characteristics of the doors on which it is to be installed. The articles required for correct installation are various and must be chosen from the moptions available both according to the characteristics and dimensions of the door and to the specific usage requirements.

To ensure the correctness and completeness of the order, below is a guide a guide for choosing the various articles that make up the set for each door.

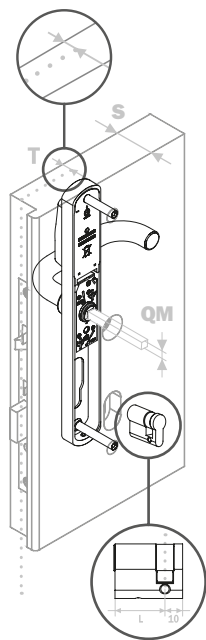

## ORDER THE PRODUCT IN A FEW STEPS

1

Check the **type and dimensions of the door** (in case of handle replacement on existing door)

3

Compose the necessary **spindle and screws kit** and check whether an **adapter plate kit is required** (for panic devices and DIN locks).

[Choose from menu](#)

[Spindle and screws kit](#)

[Adapter plate kit](#)

[Other accessories](#)

2

Choose the Aries Smart handle's model **in the right column**, generating the code thanks to the configurator on the product page

4

**Optional.**

Choose a **lock to match** from those available.

[Go to page](#)

Go to page

## SELECTION GUIDE

### MODELS

- Standard p. 30
- For panic devices p. 31
- For custom handles p. 32
- For custom handles for panic devices p. 33
- For DIN lock p. 34
- For fire locks p. 35
- For Premi Apri Meroni locks p. 36

## Aries Smart 2.0 Standard

### ELECTRONIC TRIM RFID/BLUETOOTH® SET STANDARD

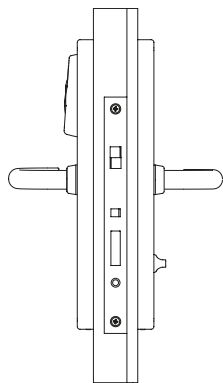

### Technical features

**FIRMWARE**  
ARGO

**RELEASE**  
2.0

**POWER UNIT**  
2 lithium batteries 3.6V type AA

**ESTIMATED BATTERY LIFE**  
Up to 2 years, up to 20.000 opening. The figure is dependent on the mode and environment of use and the options activated.

**ALERTS**  
- LEDs: 1 Green, 1 Red  
- Multi-frequency buzzer

**PRODUCT COMPATIBILITY**  
- Can be fit on any door (wooden, aluminium, metal, PVC and so on).  
- Door thickness 40 - 85 mm (with standard accessories), 85 - 120 mm (with special accessories).  
- Suitable for use fire/smoke resisting door assemblies.  
- 7, 8 or 9 (\*) mm handle follower. Center distance follower/cylinder 70, 72, 85, 88 and 92 mm.  
- Backset: 25mm minimum, if using nylon underplate to cover holes on door backset minimum 40mm. European profile cylinder hole.  
- Latchbolt only or automatic deadbolt function.  
- Max handle rotation angle 40°.

(\*) with adaptor

**MOUNTING**  
- On door

**ENVIRONMENTAL FEATURES**  
- IP55  
- IP54

**WORKING TEMPERATURE**  
-20°C ÷ +60°C

**STORAGE TEMPERATURE**  
-25°C ÷ +75°C

**PACKAGE**  
1 trim (pair), 2 batteries, 2 mm hex key, instruction manual.  
NOTE: Handle follower and fixing screws set, mechanical override cylinder and mechanical lock not included.

**ACCESSORIES (NOT INCLUDED)**  
- Handle follower and screws set (mandatory)  
- Override cylinder  
- Override keys set  
- Underplate  
- Lock

 Code configurator

 Accessories

#### DIMENSIONS

- Plate width: 38 mm;
- Plate length: 294 mm;
- Plate thickness: 17 mm;
- Handle length: 131 mm from plate center;

Weight  
1530 g

#### ONLINE CONTENT

 Web page

 User manual

 Maintenance manual

 Data sheet

 Installation guide

 Leaflet

 Specifications

## Aries Smart 2.0 For panic devices

### ELECTRONIC TRIM RFID/BLUETOOTH® SET FOR PANIC DEVICES

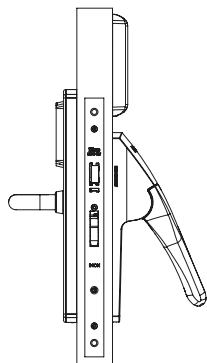

### Technical features

**FIRMWARE**  
ARGO

**RELEASE**  
2.0

**POWER UNIT**  
2 lithium batteries 3.6V type AA

**ESTIMATED BATTERY LIFE**  
Up to 2 years, up to 20.000 opening. The figure is dependent on the mode and environment of use and the options activated.

**ALERTS**  
- LEDs: 1 Green, 1 Red  
- Multi-frequency buzzer

**PRODUCT COMPATIBILITY**  
- Can be fit on any door (wooden, aluminium, metal, PVC and so on).  
- Door thickness 40 - 85 mm (with standard accessories), 85 - 120 mm (with special accessories).  
- Suitable for use fire/smoke resisting door assemblies.  
- 7, 8 or 9 (\*) mm handle follower. Center distance follower/cylinder 70, 72, 85, 88 and 92 mm.  
- Backset: 25mm minimum, if using nylon underplate to cover holes on door backset minimum 40mm. European profile cylinder hole.  
- Latchbolt only or automatic deadbolt function.  
- Max handle rotation angle 40°.

(\*) with adaptor

**MOUNTING**  
- On door

**ENVIRONMENTAL FEATURES**  
- IP55  
- IP54

**WORKING TEMPERATURE**  
-20°C ÷ +60°C

**STORAGE TEMPERATURE**  
-25°C ÷ +75°C

**PACKAGE**  
1 trim, 1 battery holder, 2 batteries, 2 mm hex key, instruction manual.  
NOTE: Handle follower and fixing screws set, adaptes kit plate, mechanical override cylinder and mechanical lock not included.

**ACCESSORIES (NOT INCLUDED)**  
- Handle follower and screws set (mandatory)  
- Override cylinder  
- Override keys set  
- Underplate  
- Lock  
- Adapter plate kit for panic devices installation

 Code configurator

 Accessories

#### DIMENSIONS

- Plate width: 38 mm;
- Plate length: 294 mm;
- Plate thickness: 17 mm;
- Handle length: 131 mm from plate center;

Weight  
1530 g

#### ONLINE CONTENT

 Web page

 User manual

 Maintenance manual

 Data sheet

 Installation guide

 Leaflet

 Specifications

## Aries Smart 2.0 For custom handles

### ELECTRONIC TRIM RFID/BLUETOOTH® SET FOR CUSTOM HANDLES

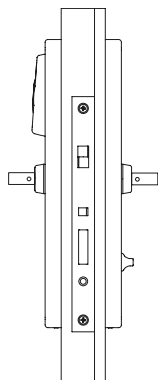

### Technical features

**FIRMWARE**  
ARGO

**RELEASE**  
2.0

**POWER UNIT**  
2 lithium batteries 3.6V type AA

**ESTIMATED BATTERY LIFE**  
Up to 2 years, up to 20.000 opening. The figure is dependent on the mode and environment of use and the options activated.

**ALERTS**  
- LEDs: 1 Green, 1 Red  
- Multi-frequency buzzer

**PRODUCT COMPATIBILITY**  
- Can be fit on any door (wooden, aluminium, metal, PVC and so on).  
- Door thickness 40 - 85 mm (with standard accessories), 85 - 120 mm (with special accessories).  
- Suitable for use fire/smoke resisting door assemblies.  
- 7, 8 or 9 (\*) mm handle follower. Center distance follower/cylinder 70, 72, 85, 88 and 92 mm.  
- Backset: 25mm minimum, if using nylon underplate to cover holes on door backset minimum 40mm. European profile cylinder hole.  
- Latchbolt only or automatic deadbolt function.  
- Max handle rotation angle 40°.

(\*) with adaptor

**MOUNTING**  
- On door

**ENVIRONMENTAL FEATURES**  
- IP55  
- IP54

**WORKING TEMPERATURE**  
-20°C ÷ +60°C

**STORAGE TEMPERATURE**  
-25°C ÷ +75°C

**PACKAGE**  
Industrial Packaging: 10 trims (pairs), 20 batteries, 2 mm hex key, instruction manual.  
NOTE: - handles, handle follower and fixing screws set, mechanical override cylinder and mechanical lock not included.  
- For custom handle specifications, please see the corresponding document on iseo.com

**ACCESSORIES (NOT INCLUDED)**  
- Handle follower and screws set (mandatory)  
- Override cylinder  
- Override keys set  
- Underplate  
- Lock

 Code configurator

 Accessories

#### DIMENSIONS

- Plate width: 38 mm;
- Plate length: 294 mm;
- Plate thickness: 17 mm;

Weight  
1530 g

#### ONLINE CONTENT

 Web page

 User manual

 Maintenance manual

 Data sheet

 Installation guide

 Leaflet

 Specifications



## Aries Smart 2.0 For custom handles for panic devices

### ELECTRONIC TRIM RFID/BLUETOOTH® SET FOR PANIC DEVICES

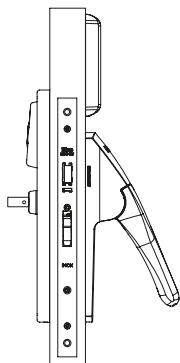

### Technical features

**FIRMWARE**  
ARGO

**RELEASE**  
2.0

**POWER UNIT**  
2 lithium batteries 3.6V type AA

**ESTIMATED BATTERY LIFE**  
Up to 2 years, up to 20.000 opening. The figure is dependent on the mode and environment of use and the options activated.

**ALERTS**  
- LEDs: 1 Green, 1 Red  
- Multi-frequency buzzer

**PRODUCT COMPATIBILITY**  
- Can be fit on any door (wooden, aluminium, metal, PVC and so on).  
- Door thickness 40 - 85 mm (with standard accessories), 85 - 120 mm (with special accessories).  
- Suitable for use fire/smoke resisting door assemblies.  
- 7, 8 or 9 (\*) mm handle follower. Center distance follower/cylinder 70, 72, 85, 88 and 92 mm.  
- Backset: 25mm minimum, if using nylon underplate to cover holes on door backset minimum 40mm. European profile cylinder hole.  
- Latchbolt only or automatic deadbolt function.  
- Max handle rotation angle 40°.

(\*) with adaptor

**MOUNTING**  
- On door

**ENVIRONMENTAL FEATURES**  
- IP55  
- IP54

**WORKING TEMPERATURE**  
-20°C ÷ +60°C

**STORAGE TEMPERATURE**  
-25°C ÷ +75°C

**PACKAGE**  
Industrial Packaging: 10 trims, 10 battery holder, 20 batteries, 2 mm hex key, instruction manual.

**NOTE:**  
- Internal and external handles, handle follower and fixing screws set, mechanical override cylinder and mechanical lock not included.  
- For custom handle specifications, please see the corresponding document on [iseo.com](http://iseo.com)

**ACCESSORIES (NOT INCLUDED)**  
- Handle follower and screws set (mandatory)  
- Override cylinder  
- Override keys set  
- Underplate  
- Lock  
- Adapter plate kit for panic devices installation

 Code configurator

 Accessories

#### DIMENSIONS

- Plate width: 38 mm;
- Plate length: 294 mm;
- Plate thickness: 17 mm;

Weight  
1530 g

#### ONLINE CONTENT

 Web page

 User manual

 Maintenance manual

 Data sheet

 Installation guide

 Leaflet

 Specifications

## Aries Smart 2.0 For DIN lock

### ELECTRONIC TRIM RFID/BLUETOOTH® SET FOR DIN LOCK

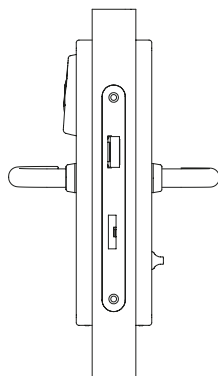

### Technical features

**FIRMWARE**  
ARGO

**RELEASE**  
2.0

**POWER UNIT**  
2 lithium batteries 3.6V type AA

**ESTIMATED BATTERY LIFE**  
Up to 2 years, up to 20.000 opening. The figure is dependent on the mode and environment of use and the options activated.

**ALERTS**  
- LEDs: 1 Green, 1 Red  
- Multi-frequency buzzer

**PRODUCT COMPATIBILITY**  
- Can be fit on any door (wooden, aluminium, metal, PVC and so on).  
- Door thickness 40 - 85 mm (with standard accessories), 85 - 120 mm (with special accessories).  
- Suitable for use fire/smoke resisting door assemblies.  
- 7, 8 or 9 (\*) mm handle follower. Center distance follower/cylinder 70, 72, 85, 88 and 92 mm.  
- Backset: 25mm minimum, if using nylon underplate to cover holes on door backset minimum 40mm. European profile cylinder hole.  
- Latchbolt only or automatic deadbolt function.  
- Max handle rotation angle 40°.

(\*) with adaptor

**MOUNTING**  
- On door

**ENVIRONMENTAL FEATURES**  
- IP55  
- IP54

**WORKING TEMPERATURE**  
-20°C ÷ +60°C

**STORAGE TEMPERATURE**  
-25°C ÷ +75°C

**PACKAGE**  
1 trim (pairs), 2 batteries, 2 mm hex key, instruction manual.  
NOTE: handle set, fastener screws, adapter plate kit, emergency cylinder and mechanical lock not included.

**ACCESSORIES (NOT INCLUDED)**  
- Handle follower and screws set (mandatory)  
- Override cylinder  
- Override keys set  
- Underplate  
- Lock  
- Adapter plate kit for DIN locks installation

 Code configurator

 Accessories

#### DIMENSIONS

- Plate width: 38 mm;
- Plate length: 294 mm;
- Plate thickness: 17 mm;
- Handle length: 131 mm from plate center;

Weight  
1530 g

#### ONLINE CONTENT

 Web page

 User manual

 Maintenance manual

 Data sheet

 Installation guide

 Leaflet

 Specifications

## Aries Smart 2.0 For fire locks

### ELECTRONIC TRIM RFID/BLUETOOTH® SET FOR FIRE LOCKS

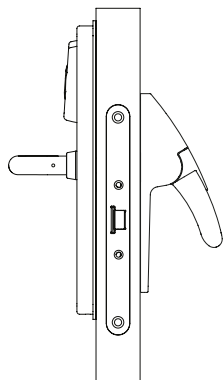

### Technical features

**FIRMWARE**  
ARGO

**RELEASE**  
2.0

**POWER UNIT**  
2 lithium batteries 3.6V type AA

**ESTIMATED BATTERY LIFE**  
Up to 2 years, up to 20.000 opening. The figure is dependent on the mode and environment of use and the options activated.

**ALERTS**  
- LEDs: 1 Green, 1 Red  
- Multi-frequency buzzer

**PRODUCT COMPATIBILITY**  
- Can be fit on any door (wooden, aluminium, metal, PVC and so on).  
- Door thickness 40 - 85 mm (with standard accessories), 85 - 120 mm (with special accessories).  
- Suitable for use fire/smoke resisting door assemblies.  
- 7, 8 or 9 (\*) mm handle follower. Center distance follower/cylinder 70, 72, 85, 88 and 92 mm.  
- Backset: 25mm minimum, if using nylon underplate to cover holes on door backset minimum 40mm. European profile cylinder hole.  
- Latchbolt only or automatic deadbolt function.  
- Max handle rotation angle 40°.

(\*) with adaptor

**MOUNTING**  
- On door

**ENVIRONMENTAL FEATURES**  
- IP54  
- IP55

**WORKING TEMPERATURE**  
-20°C ÷ +60°C

**STORAGE TEMPERATURE**  
-25°C ÷ +75°C

**PACKAGE**  
1 trim, 1 adapter plate kit, 1 handle set, 2 batteries, fastener screws, 2 mm hex key, instruction manual.  
NOTE: mechanical lock and panic devices not included.

**ACCESSORIES (NOT INCLUDED)**  
- Handle follower and screws set (mandatory)  
- Override cylinder  
- Override keys set  
- Underplate  
- Lock

 Code configurator

 Accessories

#### DIMENSIONS

- Plate width: 38 mm;
- Plate length: 294 mm;
- Plate thickness: 17 mm;
- Handle length: 131 mm from plate center;

Weight  
1530 g

#### ONLINE CONTENT

 Web page

 User manual

 Maintenance manual

 Data sheet

 Installation guide

 Leaflet

 Specifications

## Aries Smart 2.0 For Premi Apri Meroni locks

### ELECTRONIC TRIM RFID/BLUETOOTH® SET FOR PREMI APRI MERONI LOCKS

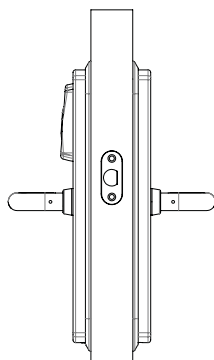

### Technical features

**FIRMWARE**  
ARGO

**RELEASE**  
2.0

**POWER UNIT**  
2 lithium batteries 3.6V type AA

**ESTIMATED BATTERY LIFE**  
Up to 2 years, up to 20.000 opening. The figure is dependent on the mode and environment of use and the options activated.

**ALERTS**  
- LEDs: 1 Green, 1 Red  
- Multi-frequency buzzer

**PRODUCT COMPATIBILITY**  
- Can be fit on any door (wooden, aluminium, metal, PVC and so on).  
- Door thickness 40 - 85 mm (with standard accessories), 85 - 120 mm (with special accessories).  
- Suitable for use fire/smoke resisting door assemblies.  
- 7, 8 or 9 (\*) mm handle follower. Center distance follower/cylinder 70, 72, 85, 88 and 92 mm.  
- Backset: 25mm minimum, if using nylon underplate to cover holes on door backset minimum 40mm. European profile cylinder hole.  
- Latchbolt only or automatic deadbolt function.  
- Max handle rotation angle 40°.

(\*) with adaptor

**MOUNTING**  
- On door

**ENVIRONMENTAL FEATURES**  
- IP54  
- IP55

**WORKING TEMPERATURE**  
-20°C ÷ +60°C

**STORAGE TEMPERATURE**  
-25°C ÷ +75°C

**PACKAGE**  
1 trim (pair) 1 plastic underplate, 2 batteries, 2 mm hex key, instruction manual.  
NOTE: handle set and fastener screws, override cylinder and mechanical lock not included.

**ACCESSORIES (NOT INCLUDED)**  
- Handle follower and screws set (mandatory)  
- Override cylinder  
- Override keys set  
- Underplate  
- Lock

 Code configurator

 Accessories

#### DIMENSIONS

- Plate width: 38 mm;
- Plate length: 294 mm;
- Plate thickness: 17 mm;
- Handle length: 131 mm from plate center;

Weight  
1530 g

#### ONLINE CONTENT

 Web page

 User manual

 Maintenance manual

 Data sheet

 Installation guide

 Leaflet

 Specifications

# Aries Smart 2.0

## Accessories

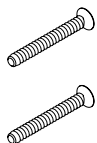

**SCREWS AND HANDLE FOLLOWER KIT**  
 2 screws M5 with threadlocking.  
 Package: 2 screws, 1 handle follower  
 NOTE: Select the right kit depending on door thickness.

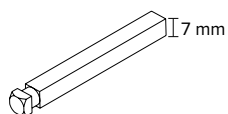

**QM 7 mm Spindle**

Door thickness <b>S</b> from 40 to 55 mm	1	201E074055A
Door thickness <b>S</b> from 55 to 70 mm	1	201E075570A
Door thickness <b>S</b> from 70 to 85 mm	1	201E077085A

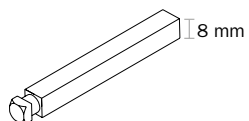

**QM 8 mm Spindle**

Door thickness <b>S</b> from 40 to 55 mm	1	201E004055A
Door thickness <b>S</b> from 55 to 70 mm	1	201E005570A
Door thickness <b>S</b> from 70 to 85 mm	1	201E007085A
Door thickness MAX 125 mm (to be cut)	1	201E008010A

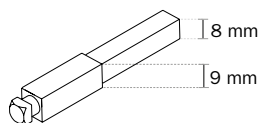

**QM 9 mm Spindle (for fire doors)**

Door thickness <b>S</b> from 40 to 55 mm	1	201E094055A
Door thickness <b>S</b> from 55 to 70 mm	1	201E095570A
Door thickness <b>S</b> from 70 to 85 mm	1	201E097085A
Door thickness <b>S</b> from 85 to 125mm	1	201E098010A

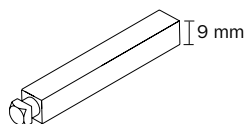

**SCREWS AND HANDLE FOLLOWERS KIT**  
 For panic devices installation.  
 Followers 9 mm and fixing screws for doors thickness up to 85 mm.  
 NOTE: to be cut according to door thickness

	1	201E915570A
--	---	-------------

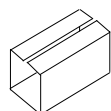

**ADAPTER FOR HANDLE FOLLOWER**  
 8 to 9 mm adapter

	10	5060000900092
--	----	---------------

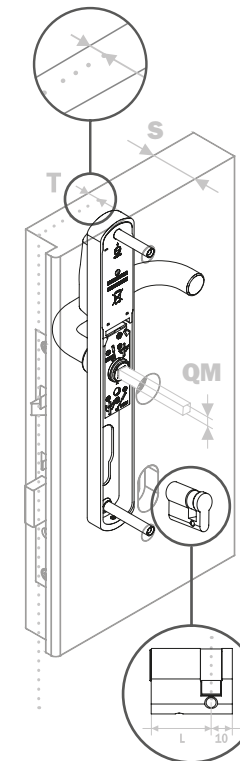

## Aries Smart 2.0

### Accessories

#### ADAPTER PLATE KIT

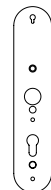

**ADAPTER PLATE KIT**  
 For panic devices installation with series 214\* panic lock case (DIN 72 mm center distance).  
 Package: 1 adapter plate.

1 529E000040

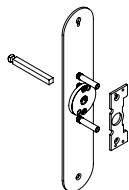

**ADAPTER PLATE KIT**  
 For RIM panic devices Idea Push installation  
 Package: plates, fixing screws, accessories.

1 567E0000540

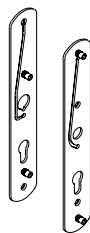

**ADAPTER PLATE KIT**  
 For DIN locks installation  
 Package: plates

1 529E080054

# Aries Smart 2.0

## Accessories

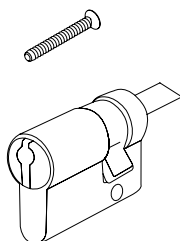

### OVERRIDE MECHANICAL CYLINDER

Monoprofile with usage detection plate. High Security ISEO R90 Factory.  
Up to 3 mechanical recordings. KA on the same installation. Nickel plated finish. Without keys.  
Package: 1 cylinder, 1 fixing screw

VISIBLE CYLINDER		HIDDEN CYLINDER	
$08 < T < 13$	L = 30 + 10 mm	$17 < T < 27$	L = 30 + 10 mm
$13 < T < 23$	L = 40 + 10 mm	$27 < T < 37$	L = 40 + 10 mm
$23 < T < 33$	L = 50 + 10 mm	$37 < T < 47$	L = 50 + 10 mm

**S** = door thickness (mm)  
**T** = distance between front plate axis of symmetry of mechanical lock and the external door edge

NOTE: Select the right dimension depending on door and lock features.  
Override keys to be ordered separately.

Lenght L 30 - 10 mm	1	82RC030A19RF.08
Lenght L 40 - 10 mm	1	82RC040A19RF.08
Lenght L 50 - 10 mm	1	82RC050A19RF.08



### OVERRIDE KEYS KIT

3 R90 keys in sequence.  
Property cards.  
Package: 3 keys, 2 property cards

	1	80RCKR0F0
--	---	-----------



### PLASTIC UNDERPLATE

Black plastic underplate to cover up eventually visible key holes.  
Dimensions: H=312 mm, L=70 mm.  
Package: 1 underplate.

	1	529E00000
--	---	-----------

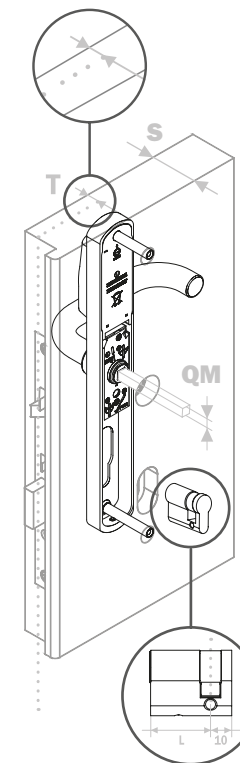

# Aries Smart 2.0

## Accessories

### AESTHETIC EXTERNAL AND INTERNAL COVER

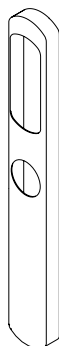

**AESTHETIC EXTERNAL COVER**  
Without cylinder hole in the cover.  
Package: 1 cover

Inox	1	561E1120240
------	---	-------------

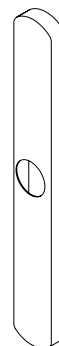

**AESTHETIC INTERNAL COVER**  
Without privacy.  
Package: 1 cover

Inox	1	561E1130240
------	---	-------------

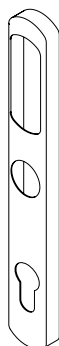

**AESTHETIC EXTERNAL COVER**  
With cylinder hole.  
Package: 1 cover

70 mm center distance

Inox	1	561E1420240
------	---	-------------

72 mm center distance

Inox	1	561E1520240
------	---	-------------

85 mm center distance

Inox	1	561E1220240
------	---	-------------

88 mm center distance

Inox	1	561E1620240
------	---	-------------

92 mm center distance

Inox	1	561E1320240
------	---	-------------

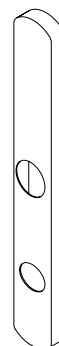

**AESTHETIC INTERNAL COVER**  
With privacy.  
Package: 1 cover

Inox	1	561E1330240
------	---	-------------



## Aries Smart 2.0

---

### Accessories

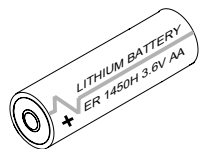

### BATTERY

#### BATTERY

High current lythium battery.

Size AA, 3,6Vcc.

10

58200000E0360

---

# Aries Smart 2.0

## Accessories

### LOCK CAN BE COMBINED (1/3)

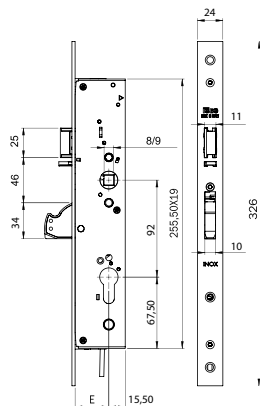

#### MULTIBLINDO EASY EXIT LATERAL.

Automatic lock with emergency function to be used with Aries.  
 Locking: deadbolt automatic relocking when the door is closed.  
 Opening: latchbolt and deadbolt operated by the handle or the key.  
 Center distance 92 mm. The microswitch detects and signals the deadbolt status.  
 Right or left latchbolt, non reversible. To be ordered separately: striking plates 03323\*.  
 Package: 1 lock, instructions.

#### ONE-PIECE HANDLE FOLLOWER 9 mm

8/9 mm square spindle code 201E094055A included.

Flat front-plate		Backset mm		
326x24x3	INOX	35 DIN SX	1	7A19163522S.A
		35 DIN DX	1	7A19163522D.A
		40 DIN SX	1	7A19164022S.A
		40 DIN DX	1	7A19164022D.A
		45 DIN SX	1	7A19164522S.A
		45 DIN DX	1	7A19164522D.A
		50 DIN SX	1	7A19165022S.A
		50 DIN DX	1	7A19165022D.A
		55 DIN SX	1	7A19165522S.A
		55 DIN DX	1	7A19165522D.A
		60 DIN SX	1	7A19166022S.A
		60 DIN DX	1	7A19166022D.A
		65 DIN SX	1	7A19166522S.A
		65 DIN DX	1	7A19166522D.A

#### ONE-PIECE HANDLE FOLLOWER 8 mm

Flat front-plate		Backset mm		
326x24x3	INOX	35 DIN SX	1	7A12163522S.A
		35 DIN DX	1	7A12163522D.A
		40 DIN SX	1	7A12164022S.A
		40 DIN DX	1	7A12164022D.A
		45 DIN SX	1	7A12164522S.A
		45 DIN DX	1	7A12164522D.A
		50 DIN SX	1	7A12165022S.A
		50 DIN DX	1	7A12165022D.A
		55 DIN SX	1	7A12165522S.A
		55 DIN DX	1	7A12165522D.A
		60 DIN SX	1	7A12166022S.A
		60 DIN DX	1	7A12166022D.A
		65 DIN SX	1	7A12166522S.A
		65 DIN DX	1	7A12166522D.A

# Aries Smart 2.0

## Accessories

### LOCK CAN BE COMBINED (2/3)

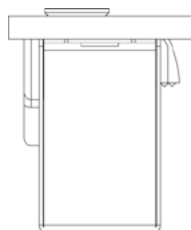

Full-size scale

ADJUSTABLE closed striking plate for CENTRAL LOCK  
MULTIBLINDO EASY.

Material: stainless steel.

With mechanical striker.

Flat front-plate 24x3x220 DIN SX

10 033230

Flat front-plate 24x3x220 DIN DX

10 033231

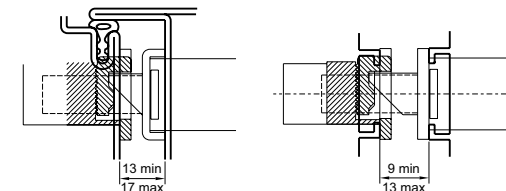
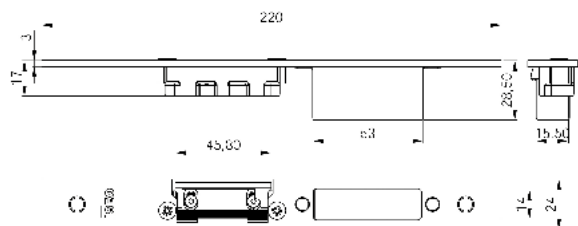

In case the space between the striking plate and the door is greater, it is necessary to use a spacer for the striking plate

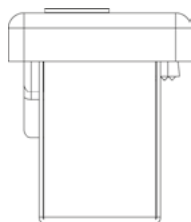

Full-size scale

ADJUSTABLE closed striking plate for CENTRAL LOCK  
MULTIBLINDO EASY.

Material: stainless steel.

With mechanical striker.

U-front plate 24x6x220 DIN SX

10 033232

U-front plate 24x6x220 DIN DX

10 033233

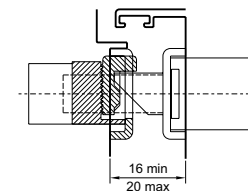
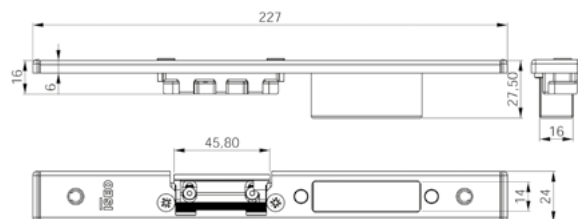

In case the space between the striking plate and the door is greater, it is necessary to use a spacer for the striking plate

# Aries Smart 2.0

## Accessories

### LOCK CAN BE COMBINED (3/3)

#### AUTOMATIC MECHANICAL LOCK

Mortise lock, automatic deadbolt function (18 mm extension)

Panic exit function, splitted latchbolt, equipped with devices against forced entry (reversible).

Backset: 55 mm, center distance: 85 mm, 8 mm handle follower

Chrome plated, squared/rounded frontplate

Package: 1 lock, 1 striking plate.

Squared frontplate	1	207553.Z
Rounded frontplate	1	217553.Z

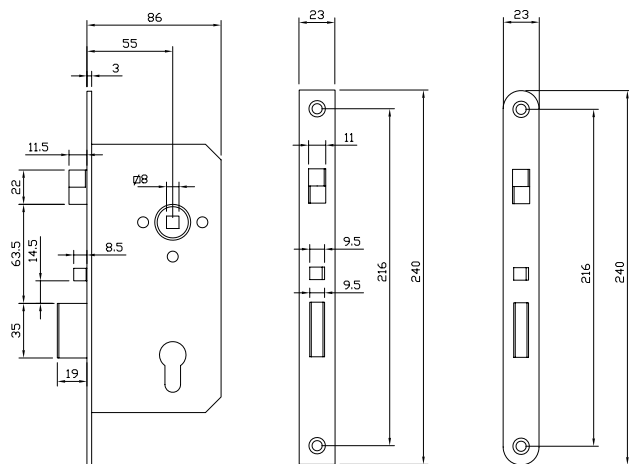

# Smart Locker 2.0

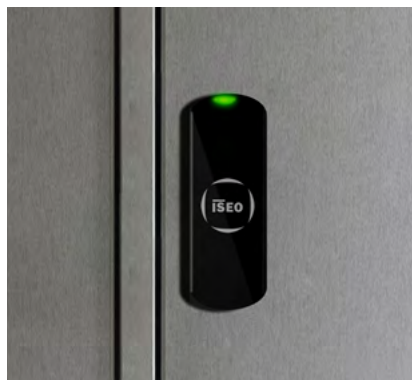

## For office, gym, swimming pool

Smart Locker can be installed on a wide range of cabinets and lockers in order to keep people's property safe while they're in the office, the gym, swimming pool, or any other situation where personal belongings need to be temporarily safeguarded.

## Automatic locking

By closing the door of the cabinet, Smart Locker will automatically lock. The Smart Lockes is battery powered allowing easy installation in new lockers or retrofit in existing lockers currently operated by keys.

## Product's functions

- Automatic locking just pulling the door ajar
- Memorize up to 300 users credentials
- Records the last 1000 events
- Battery-operated device with charge status detection
- Wake up by RFID card detection or phone Bluetooth® (patented)
- Low energy consumption device
- Real Time Clock/Calendar
- Light and acoustic signals
- Permanently open mode (office mode) without no extra battery consumption
- Block the Standard Users allowing access only to VIP users
- Programming and software updates by Argo app on iOS and Android devices

### FINISH

 Technopolymer

### COLOR

 Anthracite

### ENVIRONMENTAL CHARACTERISTICS

- IP20

### CREDENTIALS

- Badge
- Keyfob
- Bracelet
- Smartphone
- Apple Watch

### COMMUNICATION INTERFACE

- RFID ISO14443B/Mifare ISO14443A
- Bluetooth® Low Energy 5.1

Go to page

## MODELS

→ [Electronic lock for cabinets](#) p. 46

## Smart Locker 2.0 Electronic lock for cabinets

### RFID/BLUETOOTH® ELECTRONIC LOCK FOR CABINETS AND LOCKERS

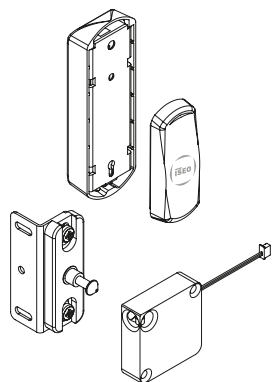

### Technical features

**FIRMWARE**  
ARGO

**RELEASE**  
2.0

**POWER UNIT**  
2 lithium batteries 3.6V type AA

**ESTIMATED BATTERY LIFE**  
Up to 2 years, up to 20.000 opening.  
The figure is dependent on the mode and environment of use and the options activated.

**ALERTS**  
- LEDs: 1 Green, 1 Red  
- Multi-frequency buzzer

**PRODUCT COMPATIBILITY**  
- Smart Locker can be installed on a wide range of cabinets and lockers in order to protect users' belongings while they are in office, gym, swimming pool or in every similar situation where people need to deposit personal items in a secure place.

**MOUNTING**  
- On door

**ENVIRONMENTAL FEATURES**  
- IP20

**WORKING TEMPERATURE**  
-20°C ÷ +60°C

**STORAGE TEMPERATURE**  
-25°C ÷ +75°C

**PACKAGE**  
1 RFID reader, 2 batteries, lock with pin latch, fixing screws, instruction manual

**ACCESSORIES (NOT INCLUDED)**  
- Battery (58200000E0360)  
- Accessori for elettrico emergency (0000IS00253)

code **1EL10155**









#### DIMENSIONS

External dimensions:  
- Width: 39mm  
- Height: 86mm

Internal dimensions:  
- Width: 40mm  
- Height: 130mm

#### ONLINE CONTENT

-  Web page
-  Data sheet
-  User manual

-  Installation guide
-  Specifications
-  Accessory for electrical emergency

## Smart Locker 2.0

---

### Accessories

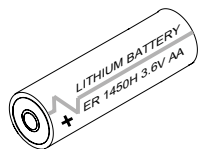

**BATTERY**  
High current lithium battery  
Size AA, 3.6 Vcc

10 58200000E0360

---



**ACCESSORY FOR ELECTRIC EMERGENCY**  
Package: 1 battery holder.  
NOTE: BATTERIES NON INCLUDED.

1 0000IS00253

---

# Libra LE60 Smart 2.1

Go to page

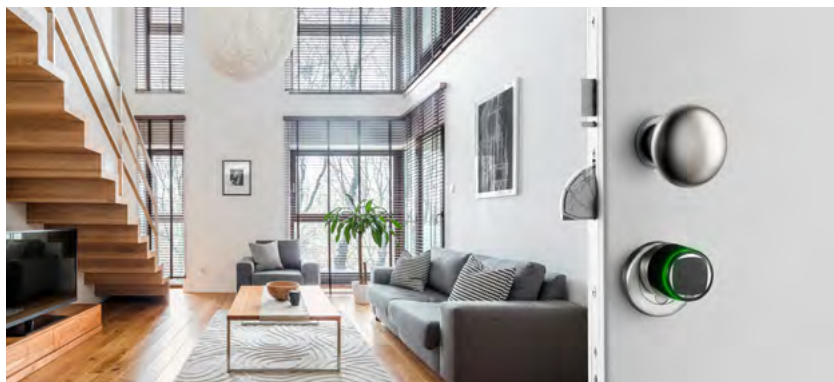

## Suitable for various applications

Thanks to the quick and easy installation, the electronic modular cylinder LIBRA is the ideal and universal solution both for the replacement of mechanical European profile cylinders and for installation on new doors.



## Simple to install

It is battery operated, so it doesn't require any electrical external cabling. The result is the best flexibility and cost effectiveness of installation, both in new doors and in retrofitting.

## Product's functions

- Memorize up to 300 users credentials
- Records the last 1000 events
- Battery-operated device with charge status detection
- Wake up by RFID card detection or phone Bluetooth® (patented)
- Low energy consumption device
- Real Time Clock/Calendar
- Light and acoustic signals
- Permanently open mode (office mode) without no extra battery consumption
- Block the Standard Users allowing access only to VIP users
- Programming and software updates by Argo app on iOS and Android devices

### FINISH

-  Stainless
-  Polished chrome
-  Polished brass

### COLOR

-  Black
-  White
-  Metal grey

### ENVIRONMENTAL CHARACTERISTICS

- IP66
- IP67
- IP68
- IP69

### CREDENTIALS

- Badge
- Keyfob
- Bracelet
- Smartphone
- Apple Watch

### COMMUNICATION INTERFACE

- RFID ISO14443B/Mifare ISO14443A
- Bluetooth® Low Energy 5.1

### CERTIFICATIONS

- EN15684:2013-01 Standard Duty version 16B4AF30 on specific models
- EN15684:2013-01 Heavy Duty version 16B4AF30 on specific models
- SKG\*\*\*for HD (Heavy Duty) version

## MODELS

- Standard p. 50
- Premium p. 51
- Half p. 52
- Double p. 53
- Removable reader and Extension plug 16 mm p. 54
- Removable reader and Extension plug 75 mm p. 55
- Dummy-knob p. 56
- Oval Australian p. 57
- Oval Scandinavian p. 58



# Libra LE60 Smart 2.1

## Selection guide

The LIBRA electronic modular cylinder represents the ideal and universal solution for access control both for retrofit installations to replace of mechanical European profile cylinders (in addition to the Australian and Scandinavian oval cylinder versions), and for installations on new doors.

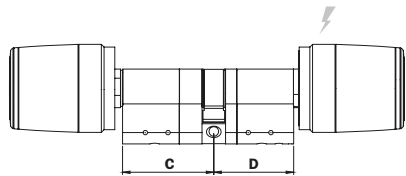

## ORDER THE PRODUCT IN A FEW STEPS

1

**Check the door type and the dimensions of the cylinder (in the case of replacement on an existing door).**

2

**Choose the Libra Smart model** in the column on the right, generating the code thanks to the configurator on the product page.

3

### Optional.

See accessory sheets for modifications and component replacements.

**Choose from menu**

[Pre-assembled modules](#)

[Modular Libra assembled components](#)

[Electronic knob spare parts](#)

[Premium knob cover \(RFID and mechanical version\)](#)

[Standard mechanical knob](#)

[Anti-intrusion accessories](#)

[Assembly/Disassembly tooling kit](#)

[Assembly tooling kit for modular cylinders](#)

[Packaging design](#)

Go to page

## SELECTION GUIDE

### MODELS

- Standard p. 50
- Premium p. 51
- Half p. 52
- Double p. 53
- Removable reader and Extension plug 16 mm p. 54
- Removable reader and Extension plug 75 mm p. 55
- Dummy-knob p. 56
- Oval Australian p. 57
- Oval Scandinavian p. 58

## Libra LE60 Smart 2.1 Standard

MODULAR CYLINDER WITH EXTERNAL RFID/BLUETOOTH® ELECTRONIC KNOB (FREE ROTATION) AND INTERNAL MECHANICAL KNOB (STANDARD TYPE)

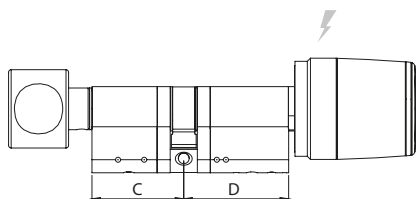

### Technical features

**FIRMWARE**  
ARGO

**RELEASE**  
2.1

**POWER UNIT**  
1.3V lithium battery type CR123

**ESTIMATED BATTERY LIFE**  
Up to 2 years, up to 20.000 opening.  
The figure is dependent on the mode and environment of use and the options activated.

**ALERTS**  
- LEDs: 1 Green, 1 Red  
- Multi-frequency buzzer

**PRODUCT COMPATIBILITY**  
- Compatible with all the mechanical locks equipped with an European profile cylinder hole (EN1303, DIN 18252)

**MOUNTING**  
- On door

### ENVIRONMENTAL FEATURES

- IP66
- IP67
- IP68
- IP69

**WORKING TEMPERATURE**  
-20°C ÷ +70°C

**STORAGE TEMPERATURE**  
-25°C ÷ +75°C

### PACKAGE

1 cylinder, 1 battery, cylinder fixing screw, 2 mm hex key, instruction sheet

### ACCESSORIES (NOT INCLUDED)

- Pre-assembled modules
- Assembled components Modular Libra
- Electronic knob spare parts
- Premium knob cover (RFID and mechanical version)
- Standard mechanical knob
- Anti-theft accessories
- Tool set for assembly/disassembly
- Modular cylinder mounting fixture
- Design packs

 Code configurator

 Accessories

### DIMENSIONS

Electronic knob dimensions:

- External diameter from 36 to 39 mm
- Length: 46mm

"Standard" mechanical knob dimensions:

- Outer diameter 30mm
- Length: 31mm

### ONLINE CONTENT

 Web page

 Data sheet

 Leaflet

 User manual

 Installation guide

 Specifications

## Libra LE60 Smart 2.1 Premium

### MODULAR CYLINDER WITH EXTERNAL ELECTRONIC RFID/BLUETOOTH® KNOB (FREE ROTATION) AND INTERNAL MECHANICAL KNOB (PREMIUM TYPE)

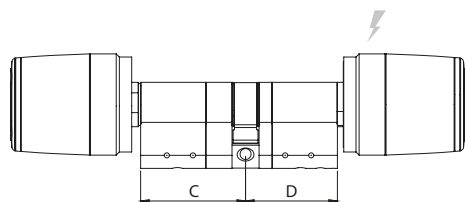

### Technical features

**FIRMWARE**  
ARGO

**RELEASE**  
2.1

**POWER UNIT**  
1.3V lithium battery type CR123

**ESTIMATED BATTERY LIFE**  
Up to 2 years, up to 20.000 opening.  
The figure is dependent on the mode and environment of use and the options activated.

**ALERTS**  
- LEDs: 1 Green, 1 Red  
- Multi-frequency buzzer

**PRODUCT COMPATIBILITY**  
- Compatible with all the mechanical locks equipped with an European profile cylinder hole (EN1303, DIN 18252)

**MOUNTING**  
- On door

### ENVIRONMENTAL FEATURES

- IP66
- IP67
- IP68
- IP69

**WORKING TEMPERATURE**  
-20°C ÷ +70°C

**STORAGE TEMPERATURE**  
-25°C ÷ +75°C

### PACKAGE

1 cylinder, 1 battery, cylinder fixing screw, 2 mm hex key, instruction sheet

### ACCESSORIES (NOT INCLUDED)

- Pre-assembled modules
- Assembled components Modular Libra
- Electronic knob spare parts
- Premium knob cover (RFID and mechanical version)
- Standard mechanical knob
- Anti-theft accessories
- Tool set for assembly/disassembly
- Modular cylinder mounting fixture
- Design packs

 Code configurator

 Accessories

### DIMENSIONS

Electronic knob dimensions:

- External diameter from 36 to 39 mm
- Length: 46mm

"Premium" mechanical knob dimensions:

- External diameter from 36 to 39 mm
- Length: 46mm

### ONLINE CONTENT

 Web page

 Data sheet

 Leaflet

 User manual

 Installation guide

 Specifications

## Libra LE60 Smart 2.1 Half

### MODULAR HALF KNOB CYLINDER WITH EXTERNAL ELECTRONIC RFID/BLUETOOTH® KNOB (FREE-ROTATING)

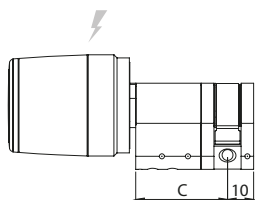

### Technical features

**FIRMWARE**  
ARGO

**RELEASE**  
2.1

**POWER UNIT**  
1.3V lithium battery type CR123

**ESTIMATED BATTERY LIFE**  
Up to 2 years, up to 20.000 opening.  
The figure is dependent on the mode and environment of use and the options activated.

**ALERTS**  
- LEDs: 1 Green, 1 Red  
- Multi-frequency buzzer

**PRODUCT COMPATIBILITY**  
- Compatible with all the mechanical locks equipped with an European profile cylinder hole (EN1303, DIN 18252)

**MOUNTING**  
- On door

### ENVIRONMENTAL FEATURES

- IP66
- IP67
- IP68
- IP69

**WORKING TEMPERATURE**  
-20°C ÷ +70°C

**STORAGE TEMPERATURE**  
-25°C ÷ +75°C

### PACKAGE

1 cylinder, 1 battery, cylinder fixing screw, 2 mm hex key, instruction sheet

### ACCESSORIES (NOT INCLUDED)

- Pre-assembled modules
- Assembled components Modular Libra
- Electronic knob spare parts
- Premium knob cover (RFID and mechanical version)
- Standard mechanical knob
- Anti-theft accessories
- Tool set for assembly/disassembly
- Modular cylinder mounting fixture
- Design packs

 Code configurator

 Accessories

### DIMENSIONS

Electronic knob dimensions:

- External diameter from 36 to 39 mm
- Length: 46mm

### ONLINE CONTENT

 Web page

 User manual

 Data sheet

 Installation guide

 Leaflet

 Specifications

## Libra LE60 Smart 2.1 Double

MODULAR CYLINDER WITH EXTERNAL ELECTRONIC RFID/BLUETOOTH® KNOB (FREE-ROTATING) AND INTERNAL ELECTRONIC KNOB (FREE-ROTATING)

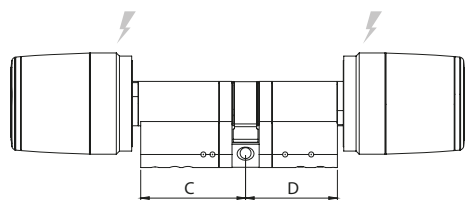

### Technical features

**FIRMWARE**  
ARGO

**RELEASE**  
2.1

**POWER UNIT**  
1.3V lithium battery type CR123

**ESTIMATED BATTERY LIFE**  
Up to 2 years, up to 20.000 opening.  
The figure is dependent on the mode and environment of use and the options activated.

**ALERTS**  
- LEDs: 1 Green, 1 Red  
- Multi-frequency buzzer

**PRODUCT COMPATIBILITY**  
- Compatible with all the mechanical locks equipped with an European profile cylinder hole (EN1303, DIN 18252)

**MOUNTING**  
- On door

### ENVIRONMENTAL FEATURES

- IP66
- IP67
- IP68
- IP69

**WORKING TEMPERATURE**  
-20°C ÷ +70°C

**STORAGE TEMPERATURE**  
-25°C ÷ +75°C

### PACKAGE

1 cylinder, 2 battery, cylinder fixing screw, 2 mm hex key, instruction sheet

### ACCESSORIES (NOT INCLUDED)

- Pre-assembled modules
- Assembled components Modular Libra
- Electronic knob spare parts
- Premium knob cover (RFID and mechanical version)
- Standard mechanical knob
- Anti-theft accessories
- Tool set for assembly/disassembly
- Modular cylinder mounting fixture
- Design packs

 Code configurator

 Accessories

### DIMENSIONS

Electronic knob dimensions:  
- External diameter from 36 to 39 mm  
- Length: 46mm

### ONLINE CONTENT

 Web page

 User manual

 Data sheet

 Installation guide

 Leaflet

 Specifications

## Libra LE60 Smart 2.1 Removable reader and Extension plug 16 mm

MODULAR CYLINDER FOR ARMORED DOORS WITH EXTERNAL ELECTRONIC RFID/BLUETOOTH® KNOB (FREE ROTATION), COMPATIBLE WITH CYLINDERS ESCUTCHEON, EXTENSION PLUG AND PRE-ARRANGED FOR INTERNAL KNOB SHAFT D 8X16 MM

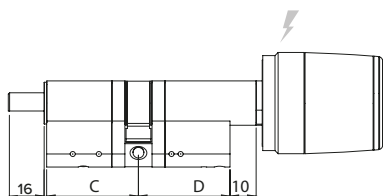

### Technical features

**FIRMWARE**  
ARGO

**RELEASE**  
2.1

**POWER UNIT**  
1.3V lithium battery type CR123

**ESTIMATED BATTERY LIFE**  
Up to 2 years, up to 20.000 opening.  
The figure is dependent on the mode and environment of use and the options activated.

**ALERTS**  
- LEDs: 1 Green, 1 Red  
- Multi-frequency buzzer

**PRODUCT COMPATIBILITY**  
- Compatible with all the mechanical locks equipped with an European profile cylinder hole (EN1303, DIN 18252)

**MOUNTING**  
- On door

### ENVIRONMENTAL FEATURES

- IP66
- IP67
- IP68
- IP69

**WORKING TEMPERATURE**  
-20°C ÷ +70°C

**STORAGE TEMPERATURE**  
-25°C ÷ +75°C

### PACKAGE

1 cylinder, 1 battery, cylinder fixing screw, 2 mm hex key, instruction sheet

### ACCESSORIES (NOT INCLUDED)

- Pre-assembled modules
- Assembled components Modular Libra
- Electronic knob spare parts
- Premium knob cover (RFID and mechanical version)
- Standard mechanical knob
- Anti-theft accessories
- Tool set for assembly/disassembly
- Modular cylinder mounting fixture
- Design packs

 Code configurator

 Accessories

### DIMENSIONS

Electronic knob dimensions:  
- External diameter from 36 to 39 mm  
- Length: 46mm

### ONLINE CONTENT

 Web page

 User manual

 Data sheet

 Installation guide

 Leaflet

 Specifications

## Libra LE60 Smart 2.1 Removable reader and Extension plug 75 mm

MODULAR CYLINDER FOR ARMORED DOORS WITH EXTERNAL ELECTRONIC RFID/BLUETOOTH® KNOB (FREE ROTATION), COMPATIBLE WITH CYLINDERS ESCUTCHEON, EXTENSION PLUG AND PRE-ARRANGED FOR INTERNAL KNOB SHAFT D 8X75 MM

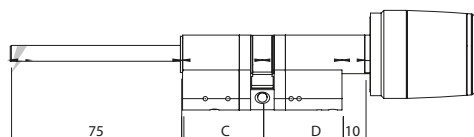

### Technical features

**FIRMWARE**  
ARGO

**RELEASE**  
2.1

**POWER UNIT**  
1.3V lithium battery type CR123

**ESTIMATED BATTERY LIFE**  
Up to 2 years, up to 20.000 opening.  
The figure is dependent on the mode and environment of use and the options activated.

**ALERTS**  
- LEDs: 1 Green, 1 Red  
- Multi-frequency buzzer

**PRODUCT COMPATIBILITY**  
- Compatible with all the mechanical locks equipped with an European profile cylinder hole (EN1303, DIN 18252)

**MOUNTING**  
- On door

### ENVIRONMENTAL FEATURES

- IP66
- IP67
- IP68
- IP69

**WORKING TEMPERATURE**  
-20°C ÷ +70°C

**STORAGE TEMPERATURE**  
-25°C ÷ +75°C

### PACKAGE

1 cylinder, 1 battery, cylinder fixing screw, 2 mm hex key, instruction sheet

### ACCESSORIES (NOT INCLUDED)

- Pre-assembled modules
- Assembled components Modular Libra
- Electronic knob spare parts
- Premium knob cover (RFID and mechanical version)
- Standard mechanical knob
- Anti-theft accessories
- Tool set for assembly/disassembly
- Modular cylinder mounting fixture
- Design packs

 Code configurator

 Accessories

### DIMENSIONS

Electronic knob dimensions:  
- External diameter from 36 to 39 mm  
- Length: 46mm

### ONLINE CONTENT

 Web page

 User manual

 Data sheet

 Installation guide

 Leaflet

 Specifications

## Libra LE60 Smart 2.1 Dummy-knob

MODULAR CYLINDER FOR ARMORED DOORS WITH EXTERNAL ELECTRONIC RFID/BLUETOOTH® KNOB (FREE ROTATION) AND KNOB-DUMMY ON INTERNAL SIDE

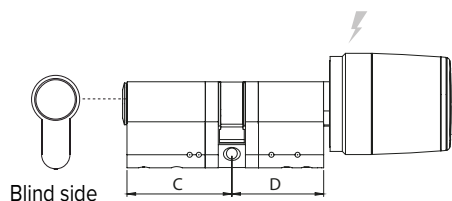

### Technical features

**FIRMWARE**  
ARGO

**RELEASE**  
2.1

**POWER UNIT**  
1.3V lithium battery type CR123

**ESTIMATED BATTERY LIFE**  
Up to 2 years, up to 20.000 opening.  
The figure is dependent on the mode and environment of use and the options activated.

**ALERTS**  
- LEDs: 1 Green, 1 Red  
- Multi-frequency buzzer

**PRODUCT COMPATIBILITY**  
- Compatible with all the mechanical locks equipped with an European profile cylinder hole (EN1303, DIN 18252)

**MOUNTING**  
- On door

### ENVIRONMENTAL FEATURES

- IP66
- IP67
- IP68
- IP69

**WORKING TEMPERATURE**  
-20°C ÷ +70°C

**STORAGE TEMPERATURE**  
-25°C ÷ +75°C

### PACKAGE

1 cylinder, 1 battery, cylinder fixing screw, 2 mm hex key, instruction sheet

### ACCESSORIES (NOT INCLUDED)

- Pre-assembled modules
- Assembled components Modular Libra
- Electronic knob spare parts
- Premium knob cover (RFID and mechanical version)
- Standard mechanical knob
- Anti-theft accessories
- Tool set for assembly/disassembly
- Modular cylinder mounting fixture
- Design packs

 Code configurator

 Accessories

### DIMENSIONS

Electronic knob dimensions:  
- External diameter from 36 to 39 mm  
- Length: 46mm

### ONLINE CONTENT

 Web page

 User manual

 Data sheet

 Installation guide

 Leaflet

 Specifications



## Libra LE60 Smart 2.1 Oval Australian

### OVAL AUSTRALIAN ELECTRONIC CYLINDER WITH EXTERNAL RFID/BLUETOOTH® ELECTRONIC KNOB (FREE ROTATION)

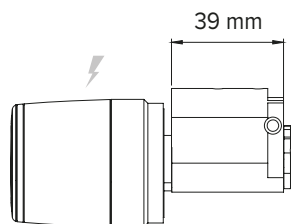

### Technical features

**FIRMWARE**  
ARGO

**RELEASE**  
2.1

**POWER UNIT**  
1.3V lithium battery type CR123

**ESTIMATED BATTERY LIFE**  
Up to 2 years, up to 20.000 opening.  
The figure is dependent on the mode and environment of use and the options activated.

**ALERTS**  
- LEDs: 1 Green, 1 Red  
- Multi-frequency buzzer

**PRODUCT COMPATIBILITY**  
- Compatible with all the mechanical locks equipped with an Australian profile cylinder hole

**MOUNTING**  
- On door

### ENVIRONMENTAL FEATURES

- IP66
- IP67
- IP68
- IP69

### WORKING TEMPERATURE

-20°C ÷ +70°C

### STORAGE TEMPERATURE

-25°C ÷ +75°C

### PACKAGE

1 cylinder, 1 battery, 2 mm hex key, instruction sheet

### ACCESSORIES (NOT INCLUDED)

- Pre-assembled modules
- Assembled components Modular Libra
- Electronic knob spare parts
- Premium knob cover (RFID and mechanical version)
- Standard mechanical knob
- Anti-theft accessories
- Tool set for assembly/disassembly
- Modular cylinder mounting fixture
- Design packs

 Code configurator

 Accessories

### DIMENSIONS

Electronic knob dimensions:

- External diameter from 36 to 39 mm
- Length: 46mm

### ONLINE CONTENT

 Web page

 User manual

 Data sheet

 Installation guide

 Leaflet

 Specifications

## Libra LE60 Smart 2.1 Oval Scandinavian

### OVAL SCANDINAVIAN ELECTRONIC CYLINDER WITH EXTERNAL ELECTRONIC RFID/BLUETOOTH® KNOB (FREE ROTATION)

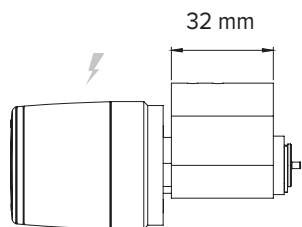

### Technical features

**FIRMWARE**  
ARGO

**RELEASE**  
2.1

**POWER UNIT**  
1.3V lithium battery type CR123

**ESTIMATED BATTERY LIFE**  
Up to 2 years, up to 20.000 opening.  
The figure is dependent on the mode and environment of use and the options activated.

**ALERTS**  
- LEDs: 1 Green, 1 Red  
- Multi-frequency buzzer

**PRODUCT COMPATIBILITY**  
- Compatible with all the mechanical locks equipped with a Scandinavian profile cylinder hole

**MOUNTING**  
- On door

### ENVIRONMENTAL FEATURES

- IP66
- IP67
- IP68
- IP69

### WORKING TEMPERATURE

-20°C ÷ +70°C

### STORAGE TEMPERATURE

-25°C ÷ +75°C

### PACKAGE

1 cylinder, 1 battery, cylinder fixing screws for internal door side versions, 2 mm hex key, instruction sheet

### ACCESSORIES (NOT INCLUDED)

- Pre-assembled modules
- Assembled components Modular Libra
- Electronic knob spare parts
- Premium knob cover (RFID and mechanical version)
- Standard mechanical knob
- Anti-theft accessories
- Tool set for assembly/disassembly
- Modular cylinder mounting fixture
- Design packs

 Code configurator

 Accessories

### DIMENSIONS

Electronic knob dimensions:

- External diameter from 36 to 39 mm
- Length: 46mm

### ONLINE CONTENT

 Web page

 User manual

 Data sheet

 Installation guide

 Leaflet

 Specifications

# Libra LE60 Smart 2.1

## Accessories



## PRE-ASSEMBLED MODULES (1/3)

### EXTERNAL WITHOUT COVER.

Multistandard RFID reader (ISO14443A/ISO14443B 13,56 Mhz) on the outside.

IP protection degree IP66/IP67/IP68/IP69 for all versions. Available Heavy Duty version with drilling protection.

2 finishes available.

Packaging: 1 knob, 1 battery, fixing screw.

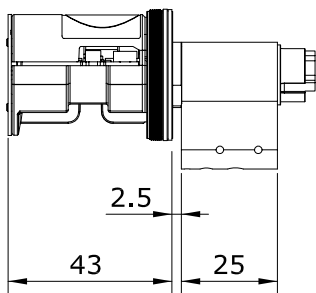

Electronic standard knob external side.

Nickel	1	8MK20K0009065
Brass	1	8MK20K0007065

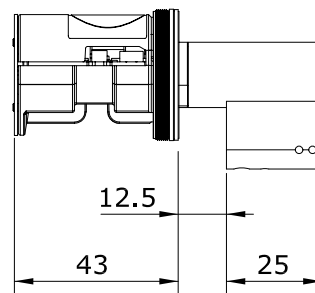

Electronic Heavy Duty knob external side removable

Nickel	1	8MK30K0009065
Brass	1	8MK30K0007065

NOTE: to be coupled only with internal module for armoured door

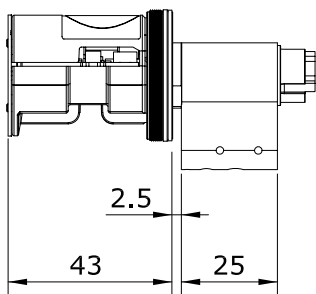

Electronic Heavy Duty knob outer side.

Nickel	1	8MK10K0009065
Brass	1	8MK10K0007065

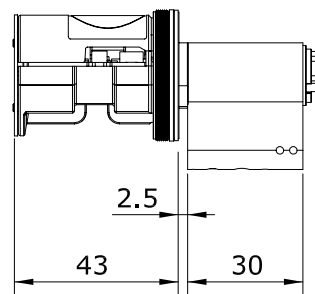

Electronic Heavy Duty knob external side removable.

Nickel	1	8MK40K0009065
Brass	1	8MK40K0007065

NOTE: to be coupled only with internal module for armoured door

## Libra LE60 Smart 2.1

### Accessories



### PRE-ASSEMBLED MODULE (2/3)

#### INTERNAL WITHOUT COVER.

Multistandard RFID reader (ISO14443A/ISO14443B 13,56 Mhz) on the inside.

IP protection degree IP66/IP67/IP68/IP69 for all versions.

2 finishes available.

Packaging: 1 knob, 1 battery, fixing screw.

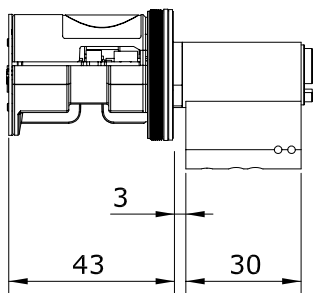

Electronic knob inside 35 mm.

Nickel	1	8MK20K1009065
Brass	1	8MK20K1007065

# Libra LE60 Smart 2.1

## Accessories

### PRE-ASSEMBLED MODULE (3/3)

INTERNAL WITHOUT KNOB.  
 2 finishes available.  
 Packaging: 1 module.

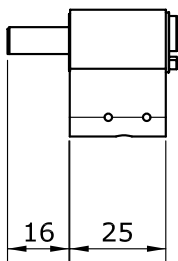

Shaft internal module 16 mm.

Nickel	1	8MK26K1009000
Brass	1	8MK26K1007000

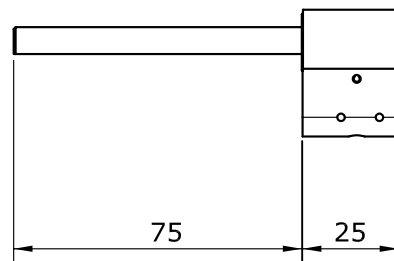

Shaft internal module 75 mm for armored door

Nickel	1	8MK3DK1009000
Brass	1	8MK3DK1007000

NOTE: to be coupled only with external module for armored door

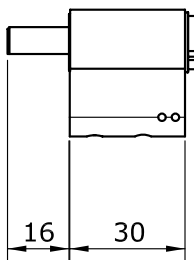

Shaft internal module 16 mm. For Panic.

Nickel	1	8MK26K1009000P
Brass	1	8MK26K1007000P

NOTE: to be coupled only with external module for armored door

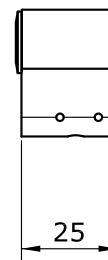

Module internal side for blind version: Libra LE60 Dummy Knob.

Nickel	1	8MK2CK1009000
Brass	1	8MK2CK1007000

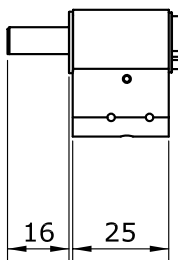

Shaft internal module 16 mm for armored door.

Nickel	1	8MK36K1009000
Brass	1	8MK36K1007000

NOTE: to be coupled only with external module for armored door

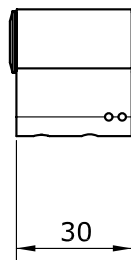

Module internal side for blind version: Libra LE60 Dummy Knob.

For Panic.		
Nickel	1	8MK2CK1009000P
Brass	1	8MK2CK1007000P

# Libra LE60 Smart 2.1

## Accessories

### MODULAR LIBRA ASSEMBLED COMPONENTS

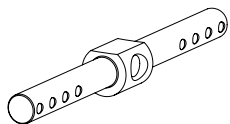

Kit 5 pcs. connecting bar for double cylinder.

3030 / 3035 / 3535	0033230
3040 / 3045 / 3540 / 3545	0033240
4040 / 4045 / 4545	0033250
3050 / 3055 / 3550 / 3555	0033260
3060 / 3065 / 3560 / 3565	0033270
4050 / 4055 / 4550 / 4555	0033280
5050 / 5055 / 5555	0033290
3070 / 3075 / 3570 / 3575	0033300
4060 / 4065 / 4560 / 4565	0033310
3080 / 3085 / 3580 / 3585	0033320
4070 / 4075 / 4570 / 4575	0033330
5060 / 5065 / 5560 / 5565	0033340
6060 / 6065 / 6565	0033350
3090 / 3095 / 3590 / 3595	0033360
4080 / 4085 / 4580 / 4585	0033370
5070 / 5075 / 5570 / 5575	0033380
4090 / 4095 / 4590 / 4595	0033390
5080 / 5085 / 5580 / 5585	0033400
6070 / 6075 / 6570 / 6575	0033410

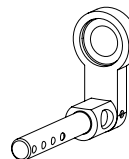

Kit 5 pcs. connecting bar for single cylinder.

3010 / 3510	0033450
4010 / 4510	0033460
5010 / 5510	0033470
6010 / 6510	0033480
7010 / 7510	0033490
8010 / 8510	0033500
9010 / 9510	0033510

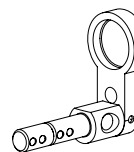

Kit 5 pcs. connecting bar for single cylinder.  
removable external control

3510	0033936
4010	0033937
4510	0033938
5010	0033939
5510	0033940
6010	0033941
6510	0033942
7010	0033943
7510	0033944
8010	0033945
8510	0033946
9010	0033947

## Libra LE60 Smart 2.1

### Accessories

### MODULAR LIBRA ASSEMBLED COMPONENTS

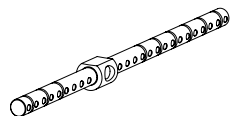

Universal connecting bar for standard version (8MK10\*/8MK20\* / 8MK18\*/8MK28\*/8MK1C\*/8MK2C\*)

Kit 2 pcs. 30÷60/30÷90 0033520

Kit 2 pcs. 30÷80/30÷180 0033552

Kit 2 pcs. 30÷130/30÷130 0033553

Universal connecting bar for special version

Kit 2 pcs. side with special function 35÷85 / 30÷90 standard side 0033935

Kit 2 pcs. side with special function 40÷90 / 30÷90 standard side 0033934

can only be cut every 10 mm

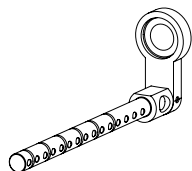

Universal connecting bar, single profile cylinder (image given for illustrative purposes only).

Kit 2 pcs. 30÷90/10 stainless steel 0033530

Kit 2 pcs. 95÷180/10 stainless steel 0033551

Connecting bar 0033551 is drilled from 95 mm

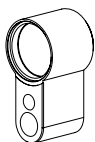

Extension for cylinder body.

Kit 5 pcs. body extension 5 mm 0033922

Kit 5 pcs. body extension 10 mm 0033923

Kit 5 pcs. body extension 15 mm 0033924

Kit 5 pcs. body extension 20 mm 0033925

Kit 5 pcs. body extension 40 mm 0033926



Extension for cylinder body.

Kit 5 pcs. body extension 5 mm 0033911

Kit 5 pcs. body extension 10 mm 0033912

Kit 5 pcs. body extension 15 mm 0033913

Kit 5 pcs. body extension 20 mm 0033914

Kit 5 pcs. body extension 40 mm 0033915

Kit 5 pcs. body extension 80 mm 0033916

## Libra LE60 Smart 2.1

### Accessories

### MODULAR LIBRA ASSEMBLED COMPONENTS

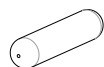

Kit 100 pcs. steel fixing pins

0033740



Kit 100 pcs. connecting ring

0033917



Kit 100 pcs. 2 Set caps electronic modular cylinder Libra body

0033919



Kit 10 pcs. Cam plug for the cylinder Libra Modular mono

0033927



Kit 10 pcs. Cam. 0° for knob modular cylinder Libra stainless steel

0033918

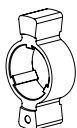

1 pcs Cam BIFFAR modular cylinder Libra stainless steel

1

0033933

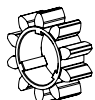

Cogwheel Z= 10 7,8 mm modular for cylinder Libra stainless steel

1

0033929



Cogwheel Z= 18 7,8 mm modular for cylinder Libra stainless steel

1

0033928



## Libra LE60 Smart 2.1

### Accessories

### ELECTRONIC KNOB SPARE PARTS

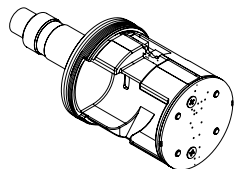

Libra LE60 Rotors, without cover, without battery.

External rotor Libra Standard	1	0033631
External rotor Heavy Duty	1	0033632
Internal rotor Libra Double	1	0033633

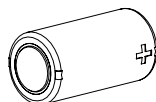

**BATTERY (compatible only with Libra LE60)**

Lithium battery FDK CR17335EF 3V 1400 mAh	1	0033960
---	---	---------

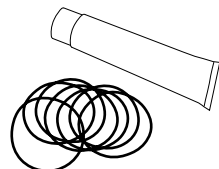

**GASKET AND GREASE COVER REPLACEMENT KIT**

Recommended to replace the cover gasket at each battery replacement (mandatory for HD version to guarantee IP66 protection degree)

Package: 20 gaskets, 1 grease tube	1	003316
------------------------------------	---	--------

## Libra LE60 Smart 2.1

### Accessories

#### “PREMIUM” KNOB COVER (RFID AND MECHANICAL VERSIONS)

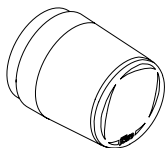

##### “PREMIUM” KNOB COVER

Suitable both for RFID reader knob and “Premium” mechanical knob.

Inox - Black	2	0444325
Inox - Metal Grey	2	0444323
Polished brass - Black	2	04443L5
Polished Chrome - White	2	04443K4
Kit 5 pcs Inox - Black	1	0444425
Kit 5 pcs Inox - Metal Grey	1	0444423
Kit 5 pcs Polished brass - Black	1	04444L5
Kit 5 pcs Polished Chrome - White	1	04444K4

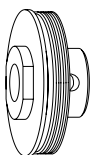

##### ADAPTER FOR MECHANICAL PREMIUM KNOB

It allows the usage of the Premium covers as mechanical inside knobs.

Package: 1 adaptor, 1 fixing screw.

	10	044240
Kit 5 pcs	1	044420

#### “STANDARD” MECHANICAL KNOB

##### “STANDARD” MECHANICAL KNOB

Internal mechanical knob.

Packaging: 1 knob, 1 battery, fixing screw.

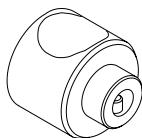

Inox	10	044232
Polished Chrome	10	04423K
Polished Brass	10	04423L
Kit 5 pcs Inox	1	044322
Kit 5 pcs Polished Chrome	1	04432K
Kit 5 pcs Polished Brass	1	04432L

## Libra LE60 Smart 2.1

### Accessories

#### ANTI-INTRUSION ACCESSORIES

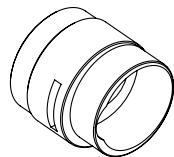

##### ANTI-INTRUSION PROTECTION KIT

For Libra cylinder, for armoured doors.

PVD polished brass	1	04425L
Satin inox	1	044252

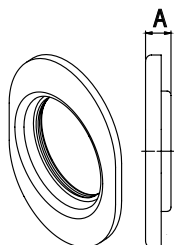

##### ANTI-INTRUSION ESCUTCHEON KIT

For Libra cylinder, for armoured doors.

A= 13 mm, PVD polished brass	1	04426L
A= 13 mm, satin inox	1	044262
A= 17 mm, PVD polished brass	1	04427L
A= 17 mm, satin inox	1	044272

## Libra LE60 Smart 2.1

### Accessories

### ASSEMBLY/DISASSEMBLY TOOLING KIT

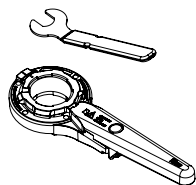

ASSEMBLY/DISASSEMBLY TOOLING KIT FOR ELECTRONIC KNOB COVER  
 Necessary for battery replacement.  
 New design with improved performances and auto assembly force detection.  
 NOT suitable for backset <45 mm.  
 Package: 1 wrench, 1 plier, instruction sheet  
 PLEASE NOTE: tool set not included with the Libra LE60. To order separately.

1 003302

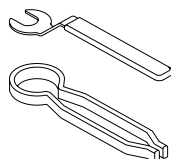

ASSEMBLY/DISASSEMBLY TOOLING KIT FOR ELECTRONIC KNOB COVER  
 Necessary for battery replacement.  
 Also suitable for backset <45 mm.  
 Package: 1 wrench, 1 plier, instruction sheet  
 PLEASE NOTE: tool set not included with the Libra LE60. To order separately.

1 003092

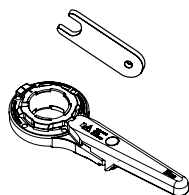

ASSEMBLY/DISASSEMBLY TOOLING KIT FOR ELECTRONIC KNOB COVER  
 installed with anti-intrusion PROTECTION kit.  
 Necessary for battery replacement.  
 New design with improved performances and auto assembly force detection.  
 NOT suitable for backset <45 mm.  
 Package: 1 wrench, 1 plier, instruction sheet.  
 PLEASE NOTE: tool set not included with the Libra LE60. To order separately.

For code 04425L - 044252

1 003317

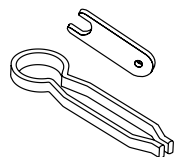

ASSEMBLY/DISASSEMBLY TOOLING KIT FOR ELECTRONIC KNOB COVER  
 installed with burglary protection ring.  
 Necessary for battery replacement  
 Also suitable for backset <45 mm.  
 Package: 1 wrench, 1 plier, instruction sheet.  
 PLEASE NOTE: tool set not included with the Libra LE60. To order separately.

For code 04425L - 044252

1 003301

## Libra LE60 Smart 2.1

### Accessories

### ASSEMBLY TOOLING KIT FOR MODULAR CYLINDERS

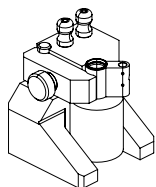

#### INSTALLATION TOOL FOR MODULAR CYLINDER LE60

Tool necessary for the assembly of modular cylinders.

Package: installation tool, 2 blocking pins

NOTE: the cylinders are supplied WITHOUT this tool. ORDER SEPARATELY.

1 0033097

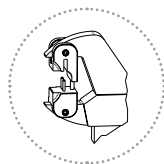

Pin driver tool on modular cylinder clamp

1 0033094

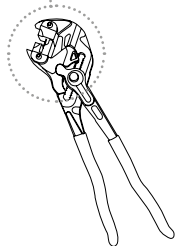

## Libra LE60 Smart 2.1

---

### Accessories

### PACKAGING DESIGN (1/3)



<p><b>Kit Libra modular</b></p> <p>Package: 1 cylinder 8MK2830302565 with 1 battery fixing screw, 2 mm hex key, instruction sheet. 1 master card set 5E405309.3</p>	1	0033641
<p><b>Kit Libra Pre-Assembled external module with cover</b></p> <p>Package: 1 external electronic module 8MK20K0009065 with inox-black cover with 1 battery, fixing screw, 2 mm hex key, instruction sheet. 1 master card set 5E405309.3</p>	1	0033642

## Libra LE60 Smart 2.1

### Accessories

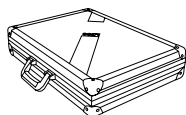

### PACKAGING DESIGN (2/3)

Assembly case Libra LE60 Smart electronic modular cylinder  
(image given for illustrative purposes only). 0033962

#### ASSEMBLY CASE CONTENT

Kit 5 pcs. connecting bar for double cylinder.

3030 / 3035 / 3535	0033230
3040 / 3045 / 3540 / 3545	0033240
4040 / 4045 / 4545	0033250
3050 / 3055 / 3550 / 3555	0033260
3060 / 3065 / 3560 / 3565	0033270
4050 / 4055 / 4550 / 4555	0033280
5050 / 5055 / 5555	0033290

Extension for cylinder body.

Kit 5 pcs. body extension 5 mm	0033922
Kit 5 pcs. body extension 10 mm	0033923
Kit 5 pcs. body extension 15 mm	0033924
Kit 5 pcs. body extension 20 mm	0033925
Kit 5 pcs. body extension 40 mm	0033926

Kit 2 pcs. universal bar, drilled, single profile cylinder,  
80/180 stainless steel 0033552

Kit 2 pcs. universal bar, drilled, single profile cylinder,  
180/10 stainless steel 0033551

Plug extension.

Kit 5 pcs. plug extension 5 mm	0033911
Kit 5 pcs. plug extension 10 mm	0033912
Kit 5 pcs. plug extension 15 mm	0033913
Kit 5 pcs. plug extension 20 mm	0033914
Kit 5 pcs. plug extension 40 mm	0033915

Kit 100 pcs. steel fixing pins 0033740

Kit 100 pcs. connecting ring, inox, mod. D15 0033917

Kit 10 pcs. cam DIN 0° 0033918

## Libra LE60 Smart 2.1

### Accessories

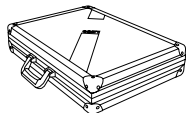

### PACKAGING DESIGN (3/3)

Demo Case for Libra LE60 2.1 electronic modular cylinder  
(image given for illustrative purposes only). 0033643

#### ASSEMBLY CASE CONTENT

Libra LE60 cylinders assembled  
Libra LE60 Smart - Electronic modular cylinder,  
Electronic/Mechanic standard 30-30 8MK2830302565

Libra LE60 Smart - Electronic modular cylinder,  
Electronic/Mechanic removable external knob 30-50 8MK483050K465

5 pz demo card ARGO DESFIRE EV2 2K ISEO logo 5E40530K.5

Pin driver tool on modular cylinder clamp 0033094

Assembly/disassembly tooling kit for electronic knob cover 003092

Lythium battery FDK CR17335EF 3V 1400 mAh 0033960

Extension for cylinder body for Libra LE60 modular electronic cylinder.

3 pcs. body extension 5 mm L=35 0033922

3 pcs. body extension 10 mm L=40 0033923

3 pcs. body extension 15 mm L=45 0033924

3 pcs. body extension 20 mm L=50 0033925

3 pcs. body extension 40 mm L=70 0033926

1 pcs universal bar, drilled, L=85 double profile cylinder (kit da 1 pz) 0033270

1 pcs universal bar, drilled, L=105 double profile cylinder (kit da 1 pz) 0033320

1 pcs universal bar, drilled, single profile cylinder, 35/10 (kit da 1 pz) 0033936

1 pcs universal bar, drilled, single profile cylinder, 50/10 (kit da 1 pz) 0033939

Plug extension.

3 pcs. plug extension 5 mm 0033911

3 pcs. plug extension 10 mm 0033912

3 pcs. plug extension 15 mm 0033913

3 pcs. plug extension 20 mm 0033914

3 pcs. plug extension 40 mm 0033915

3 pcs. plug extension 80 mm 0033916

100 pcs. steel fixing pins 0033740

100 pcs. connecting ring, inox, mod. D15 0033917

10 pcs. cam DIN 0° 0033918



# Smart Relay 2.0

Go to page

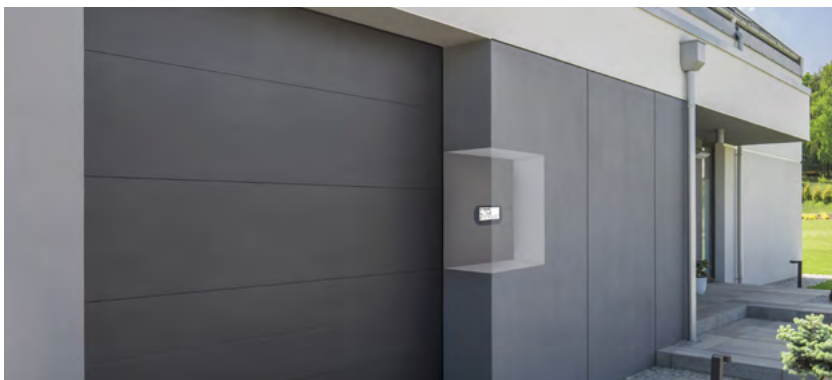

## Make your access points smart

The Smart Relay allows to open electric locks, motorized gate or any electrical actuator which can be activated closing a contact.

## Concealed installation

The Smart Relay device can have an integrated or external Bluetooth® antenna, in order to install the device even in unconventional installation spaces: the antenna can be installed in another point and connected to the device.

## Product's functions

- REX (REquest to eXit) is an Opto-insulated input to open the relay with a button distant up to 100 meters.
- The OUTPUT relay is a signal relay (1A) and can be also configured as NO (default) or NC by a jumper under the cover enclosure. It can be configured with the Argo App for different functions.
- Memorize up to 300 users credentials
- Records the last 1000 events
- Wake up by RFID card detection or phone Bluetooth® (patented)
- Block the Standard Users allowing access only to VIP users
- Programming and software updates by Argo app on iOS and Android devices

## MODELS

- Built in Bluetooth® p. 75
- External Bluetooth® (max 3 meters) p. 76

### ENVIRONMENTAL CHARACTERISTICS

- Max. 95% without condensing

### CREDENTIALS

- Smartphone
- Apple Watch

### COMMUNICATION INTERFACE

- Bluetooth® Low Energy 5.1

# Smart Relay 2.0

## Selection guide

Smart Relay controls electric locks, motorised gates or any electrical actuator that can be activated by closing a contact. The Smart Relay closes a contact if a smartphone has been registered on the device. Smart Relay is available in two versions, which adapt to different installation requirements.

## ORDER THE PRODUCT IN A FEW STEPS

1

Choose the appropriate template for your application and click in the column on the right :

### Smart Relay with integrated Bluetooth® antenna

Device used for installations where there are no range problems of the Bluetooth® signal (approx. 10 m between smartphone and Smart Relay).

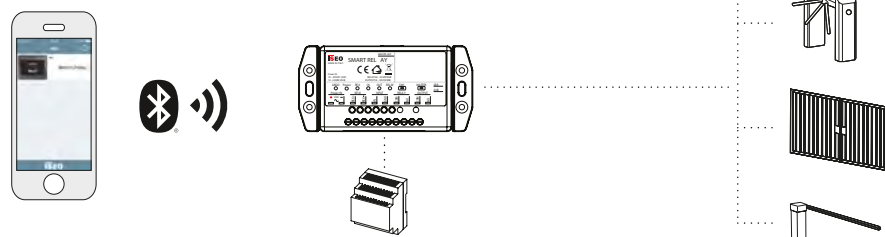

### Smart Relay with external Bluetooth® antenna

To be used in case it is necessary to remote the Bluetooth® antenna from the installation of the Smart Relay. The length of the cable supplied for the external antenna is 3 m.

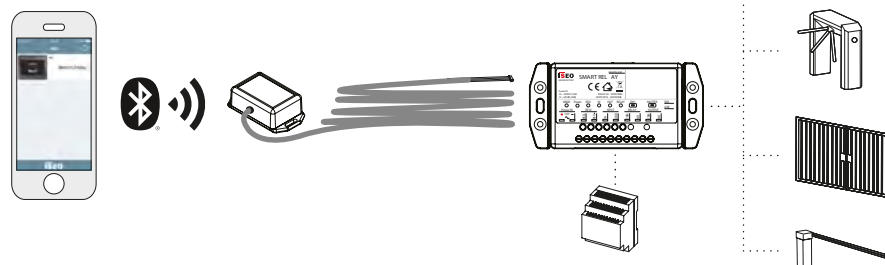

Go to page

## SELECTION GUIDE

### MODELS

- Built in Bluetooth® p. 75
- External Bluetooth® (max 3 meters) p. 76

## Smart **Relay** 2.0 Built in Built in Bluetooth®

### CONNECTED ACTUATOR WITH BUILT IN BLUETOOTH®

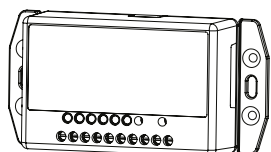

### Technical features

**FIRMWARE**  
 ARGO

**RELEASE**  
 2.0

**POWER UNIT**  
 10÷30 Vdc (2W)  
 12÷24 Vac (4VA)

**MOUNTING**  
 - Wall mounted  
 - Flush mounted  
 - DIN Rail 35 mounted

**ENVIRONMENTAL FEATURES**  
 - H.R. max. 95% without condensing

**WORKING TEMPERATURE**  
 -25°C ÷ +70°C

**STORAGE TEMPERATURE**  
 -25°C ÷ +70°C

**PACKAGE**  
 1 Smart Relay, 1 Plastic pin to setup Programming Mode, 1 DIN rail mounting clip with screws, 1 Installation guide (EN/IT)

code **5E065501**

#### DIMENSIONS

- Width: 109mm
- Height: 53mm
- Thickness: 26mm

### ONLINE CONTENT

- Web page
- Data sheet
- User manual

- Installation guide
- Specifications

- Door entry system solution with Smart Relay and electric gate
- Door entry system solution with Smart Relay and Multiblindo eMotion.
- Door entry system solution with Smart Relay and IS9100 automatic door operator

## Smart Relay 2.0 External Bluetooth® (max 3 meters)

### CONNECTED ACTUATOR WITH EXTERNAL BLUETOOTH®

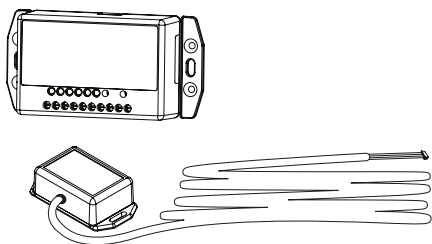

### Technical features

**FIRMWARE**  
ARGO

**RELEASE**  
2.0

**POWER UNIT**  
10÷30 Vdc (2W)  
12÷24 Vac (4VA)

**MOUNTING**  
- Wall mounted  
- Flush mounted  
- DIN Rail 35 mounted

**ENVIRONMENTAL FEATURES**  
- H.R. max. 95% without condensing

**WORKING TEMPERATURE**  
-25°C ÷ +70°C

**STORAGE TEMPERATURE**  
-25°C ÷ +70°C

**PACKAGE**  
1 Smart Relay, 1 Plastic pin to setup Programming Mode, 1 DIN rail mounting clip with screws, 1 Bluetooth® remote module with 3 meters cable, 1 Installation guide (EN/IT)



code **5E065502**



#### DIMENSIONS



Smart Relay's dimensions:  
- Width: 109mm  
- Height: 53mm  
- Depth: 26 mm

Bluetooth Antenna's dimensions:  
- Width: 65mm  
- Height: 35mm  
- Depth: 15mm

#### ONLINE CONTENT

-  Web page
-  Data sheet
-  User manual

-  Installation guide
-  Specifications

-  Door entry system solution with Smart Relay and electric gate
-  Door entry system solution with Smart Relay and Multiblindo eMotion.
-  Door entry system solution with Smart Relay and IS9100 automatic door operator

# Multiblindo Smart



## Choose the configuration that best suits your needs

The new ISEO self-closing motorized lock is the perfect combination of comfort of use and safety in all situations. The great innovation of Multiblindo Smart is the possibility of choosing between different configurations, completely battery powered or mains powered, with or without backup battery, to be used in the event of an electrical blackout.

## Open as you like

The installation of Multiblindo Smart locks is recommended to protect entrances of homes, offices, commercial spaces and bed & breakfasts. In combination with the new ones 1NCA readers and using your smartphone, manage access to your spaces intuitively and secure, monitoring activities in real time and simplifying permission management. The sensors on board the lock guarantee constant monitoring of access and of the door status, visible on smartphones and tablets.

### MATERIAL

Stainless steel

## Product features

- Closing the leaf, the lock engages the deadbolts automatically
- Memorize up to 300 users credentials
- Records the last 1000 events
- Wake up by RFID card detection or phone (patented)
- Low energy consumption device
- Real Time Clock/Calendar
- Permanently open mode (office mode) without extra battery consumption
- Door Status option with cable with Relay Output to manage an automatic door operator or to be used for home automation systems
- Block the Standard Users allowing access only to VIP users
- Programming and software updates by Argo app on iOS and Android devices

Go to page

### CONFIGURATIONS

- Full battery p. 79
- Powered by 24Vdc with backup batteries p. 80
- Powered by 24Vdc p. 81

### MODELS

- Multiblindo Smart p. 82

### ACCESS CREDENTIALS

- Apple Watch
- Badge
- Bracelet
- Numeric Keypad
- Fingerprint
- Keyfob
- Smartphone

### COMMUNICATION INTERFACE

- Check the communication interfaces of lock's compatible readers

### CERTIFICATIONS

- EN 14846:2008 with the classification |3|X|9|E|0|P|7|1|1|3|
- EN 179: 2008 with the classification |3|7|7|B|1|4|5|2|3|
- EN1125 certification available in combination with specific panic devices and locks

# Multiblindo Smart

## Selection guide

Multiblindo Smart features a modular design to suit various installation needs. This catalog allows you to select the desired configuration for the lock, define the necessary components, and check the connections.

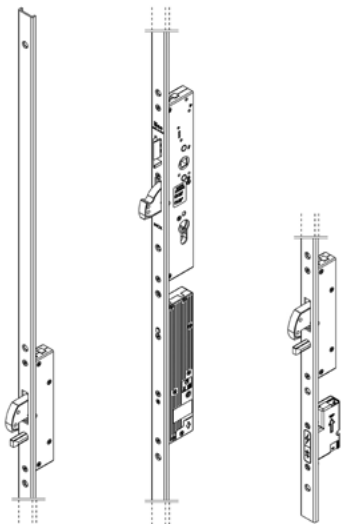

## ORDER THE PRODUCT IN A FEW STEPS

1

Check **the type of application and the available installation spaces**, particularly assessing whether it is possible to run a power cable to the door.

3

**Optional.**  
Refer to the accessory sheets for component modifications and replacements.

Choose from menu

[Connection box](#)

[Connection cables](#)

[Batteries](#)

[Power supply unit](#)

2

Choose **the desired configuration and lock model in the right column**, generating the code using the configurator on the product page.

4

Choose **the suitable 1NCA Smart reader model** for your application.

**Note: Verify the compatibility of the reader with the desired Multiblindo Smart configuration.**

Choose the 1NCA Smart reader.

Go to page

## SELECTION GUIDE

### CONFIGURATIONS

- Full battery p. 79
- Powered by 24Vdc with backup batteries p. 80
- Powered by 24Vdc p. 81

### MODELS

- Multiblindo Smart p. 82

# Multiblindo Smart



## Full battery

No wiring is required. The lock **operates only using alkaline batteries**.

There are two battery packs on the door (9 Alkaline AA batteries in total).

In this configuration, **1NCA Smart Readers Cable Free** can be used if needed. If no reader is paired, the lock can still be managed with the **ARGO smartphone app**.

**It is not possible to install** an output relay in this configuration to monitor the door status or manage a swing door operator.

## Reader type



### 1NCA Smart Cable Free

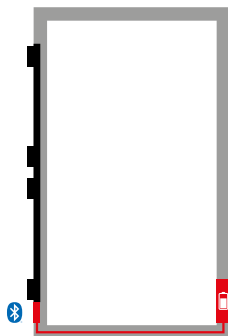

Installation guide  
for the configuration



### No Reader

The lock can be managed  
using the **ARGO app**  
from a smartphone.

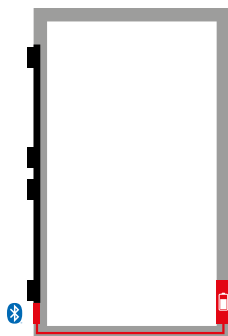

Installation guide  
for the configuration



You can choose the **1NCA Smart** reader model suitable for your application in the dedicated section of the catalog.

**Note:** Verify the compatibility of the reader with the desired **Multiblindo Smart** configuration.

Go to page

## SELECTION GUIDE

### CONFIGURATIONS

- Full battery p. 79
- Powered by 24Vdc  
with backup batteries p. 80
- Powered by 24Vdc p. 81

### MODELS

- Multiblindo Smart p. 82

# Multiblindo Smart



Powered by 24Vdc with backup batteries

The power supply is provided by an **external 24Vdc power** adapter connected to the electrical network, and there is a **backup battery pack (9 Alkaline AA)** on the door to keep the lock operational in case of power outage (blackout).

In this configuration, **1NCA Smart Cable Free** and **1NCA Smart Standard** can be used if required (you can choose the desired model in this catalog).

If no reader is paired, the lock can still be managed with the **ARGO app from a smartphone**.

Additionally, you can add an **output relay** to monitor the door status or manage an automatic door operator.

## Reader type

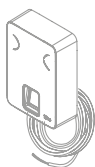

1NCA Smart Standard

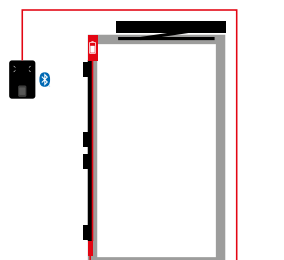

Installation guide for the configuration with output relay

[BKW+R]

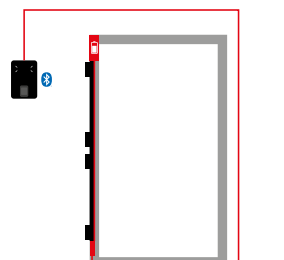

Installation guide for the configuration without output relay

[BKW]



1NCA Smart Cable Free

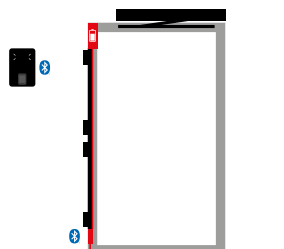

Installation guide for the configuration with output relay

[BKF+R]

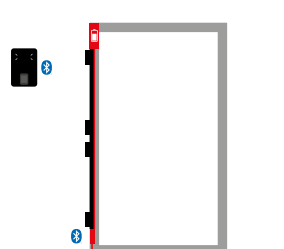

Installation guide for the configuration without output relay

[BKF]

## No Reader

The lock can be managed using the **ARGO app** from a smartphone.

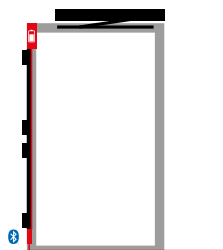

Installation guide for the configuration with output relay

[BKF+R]

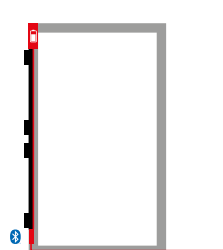

Installation guide for the configuration without output relay

[BKF]

You can choose the **1NCA Smart reader model** suitable for your application in the dedicated section of the catalog.

**Note:** Verify the compatibility of the reader with the desired Multiblindo Smart configuration.

Go to page

## SELECTION GUIDE

### CONFIGURATIONS

- Full battery p. 79
- Powered by 24Vdc with backup batteries p. 80
- Powered by 24Vdc p. 81

### MODELS

- Multiblindo Smart p. 82



# Multiblindo Smart



The power supply is provided by an external 24V power adapter connected to the electrical network. In this configuration, **1NCA Smart Cable Free**, **1NCA Smart Standard** or **1NCA Smart Mullion 485** can be used if required (you can choose the desired model in this catalog). If no reader is paired, the lock can still be managed with the **ARGO app from a smartphone**. Additionally, you can add an **output relay** to monitor the door status or manage an automatic door operator.

## Reader type

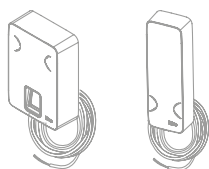

**1NCA Smart Standard**   **1NCA Smart Mullion 485**

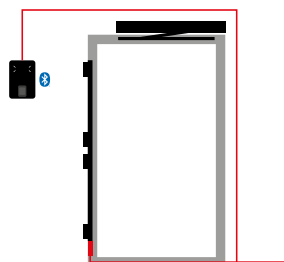

Installation guide for the configuration with output relay  
 [PWW+R]

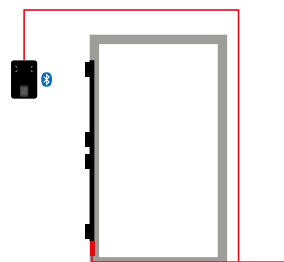

Installation guide for the configuration without output relay  
 [PWW]



**1NCA Smart Cable Free**

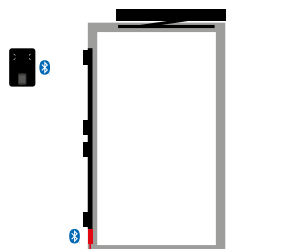

Installation guide for the configuration with output relay  
 [PWF+R]

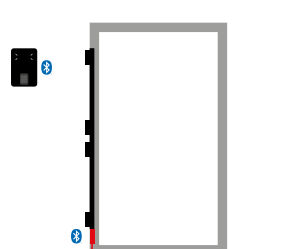

Installation guide for the configuration without output relay  
 [PWF]

**No Reader**  
 The lock can be managed using the **ARGO app from a smartphone**.

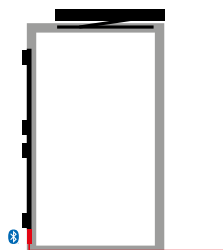

Installation guide for the configuration with output relay  
 [PWF +R]

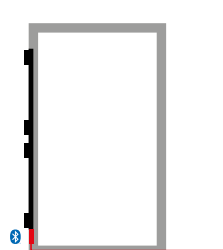

Installation guide for the configuration without output relay  
 [PWF]

You can choose the **1NCA Smart reader model** suitable for your application in the dedicated section of the catalog.

**Note:** Verify the compatibility of the reader with the desired Multiblindo Smart configuration.

Go to page

## SELECTION GUIDE

### CONFIGURATIONS

- Full battery p. 79
- Powered by 24Vdc with backup batteries p. 80
- Powered by 24Vdc p. 81

### MODELS

- Multiblindo Smart p. 82

## Multiblindo Smart

MOTORIZED SELF-LOCKING MULTI-POINT LOCK, WITH A HIGH LEVEL OF SECURITY, SUITABLE FOR METAL FRAME DOORS MULTIPLE LOCKING POINTS, TO BE COMBINED WITH CONNECTION BOX

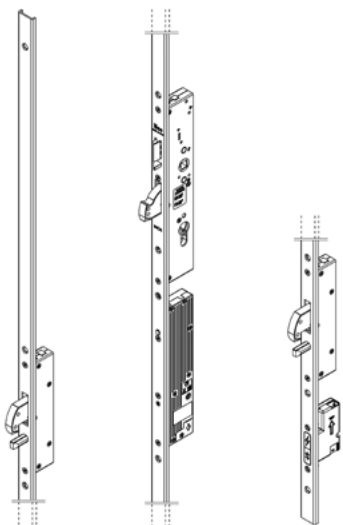

### Technical features

**FIRMWARE**  
ARGO

**POWER UNIT**

Configurable power:

- 24Vdc mains power supply
- 24Vdc mains power supply and backup battery on the door (which guarantees the use of the access even if the main power supply is interrupted)
- Battery powered (no cable needed for main power)

**HARDWARE SPECIFICATIONS**

- Electromechanical 24vdc multipoint mortice lock for metal frames, self-locking latchbolt and 3 deadbolts, rotating hook deviators and pin. Deadbolts and latchbolt operated by key, handle or motor. Lock and deviators deadbolts with anti-drill and anti-cut cover plates in hardened steel. Adapter for 8 mm square handle, 2 nylon end blocks for U-version.

**ALERTS**

- Multi-frequency buzzer

**PRODUCT COMPATIBILITY**

- The addition of the 1NCA Smart Cable Free or 1NCA Smart Standard readers allows entry with different electronic credentials, configuration, validity and times. Up to 300 credentials in total can be combined with the lock.
- For metal frame doors with multiple locking points.
- European profile cylinder.

**MOUNTING**

- On door

**ENVIRONMENTAL FEATURES**

- H.R. max. 95% without condensing

**WORKING TEMPERATURE**

-20°C ÷ +70°C

**STORAGE TEMPERATURE**

-20°C ÷ +70°C

**PACKAGE**

1 Multipoint lock L 2300 mm, Door status magnet, lock fixing screws, installation manual.

**ACCESSORIES (NOT INCLUDED)**

- Connection Box (see operating and power configurations)
- Motor/Connection Box cable (see operating configurations)
- Flexible cable for rim and mortice mounting
- Battery pack
- Batteries
- Counterplates
- Magnet holder
- Emergency handle or panic bar
- Emergency mechanical cylinder
- Extensions

 Code configurator

 Accessories

**DIMENSIONS**

Lock length 2300 mm, center distance 92 mm.  
Lock and deviators deadbolts 27 mm throw.  
Connection cable length 6m (not included).

**ONLINE CONTENT**

 Web page

 Installation guide

 Data sheet

 Specifications

 Leaflet

# Multiblindo Smart

## Accessories

### CONNECTION BOX

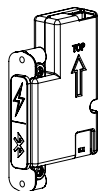
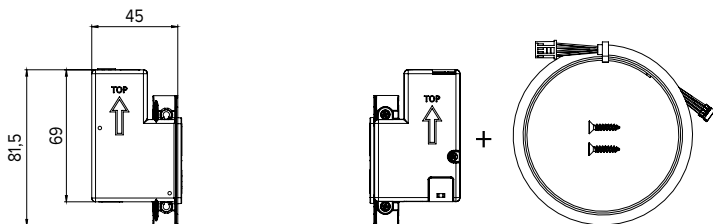

#### CONNECTION BOX FOR EXTERNAL 24VDC POWER SUPPLY, WITH BLUETOOTH®

Used in Multiblindo Smart configurations Powered by 24Vdc with Cable Free reader (PWF) and Powered by 24Vdc with Cable Free reader and output relay (PWF+R).

Package: 1 Connection Box, 1 cable, instruction manual.

1

7A0E110

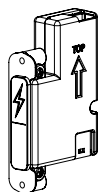

#### CONNECTION BOX FOR EXTERNAL WIRED POWER SUPPLY, WITHOUT BLUETOOTH®

Used in Multiblindo Smart configurations Powered by 24Vdc with wired reader (PWW) and Powered by 24Vdc with wired reader and output relay (PWW+R).

Package: 1 Connection Box, 1 cable, instruction manual.

1

7A0E120

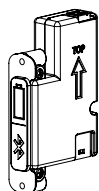

#### CONNECTION BOX FOR CONFIGURATION WITH BACKUP BATTERIES, WITH BLUETOOTH®

Used in Multiblindo Smart configurations Powered by 24Vdc with backup batteries and Cable Free reader (BKF), Powered by 24Vdc with backup batteries, Cable Free reader and Relay (BKF+R) and Full Battery (FB), version without external 24Vdc power supply.

Package: 1 Connection Box, 1 cable, instruction manual.

1

7A0E130

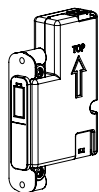

#### CONNECTION BOX FOR CONFIGURATION WITH BACKUP BATTERIES, WITHOUT BLUETOOTH®

Used in Multiblindo Smart configurations Powered by 24Vdc with backup batteries and wired reader (BKW) and Powered by 24Vdc with backup batteries, wired reader and output relay (BKW+R).

Package: 1 Connection Box, 1 cable, instruction manual.

1

7A0E140

# Multiblindo Smart

## Accessories

### CONNECTION CABLES AND BATTERIES

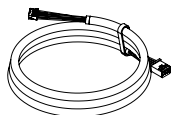

#### 6-WIRE CONNECTION CABLE FOR MULTIBILINDO SMART

Used in Multiblindo Smart configurations Powered by 24Vdc with wired reader (PWW) and Powered by 24Vdc with backup batteries with wired reader (BKW).

Package: 1 Connection Cable 1 7A0E200

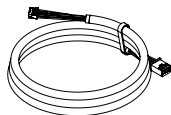

#### 4-WIRE CONNECTION CABLE FOR MULTIBILINDO SMART

Used in Multiblindo Smart configurations Powered by 24Vdc with Cable Free reader (PWF) and Powered by 24Vdc with backup batteries with Cable Free reader (BKF).

Package: 1 Connection Cable 1 7A0E210

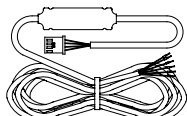

#### 6-WIRE CONNECTION CABLE FOR MULTIBILINDO SMART

Used in Multiblindo Smart configurations Powered by 24Vdc with Cable Free reader and output relay (PWF+R) and Powered by 24Vdc with backup batteries, Cable Free reader and output relay (BKF+R)

Package: 1 Connection Cable 1 7A0E220

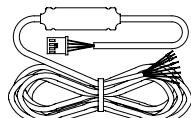

#### 8-WIRE CONNECTION CABLE FOR MULTIBILINDO SMART

Used in Multiblindo Smart configurations Powered by 24Vdc with wired reader and output relay (PWF+R) and Powered by 24Vdc with backup batteries, wired reader and output relay (BKF+R)

Package: 1 Connection Cable 1 7A0E230

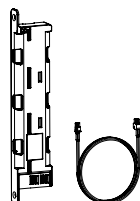

#### SINGLE BATTERY HOLDER + CONNECTION CABLE

Single battery holder in black nylon for 9 type AA batteries. Compatible with MULTIBLINDO SMART, supplied with connection cable. (batteries not provided).

Package: 1 Battery holder, 1 connection cable 1 7A0E300

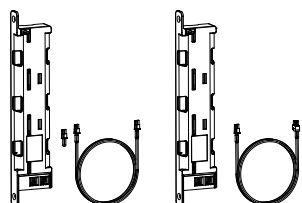

#### DOUBLE BATTERY HOLDER + CONNECTION CABLES

Double battery holder in black nylon for 9x2 type AA batteries. Compatible with MULTIBLINDO SMART, supplied with connection cables. (batteries not provided).

Package: 2 Battery holder, 2 connection cable 1 7A0E310

#### PACKAGE 9 BATTERIES

Duracell Procell AA alkaline battery 1 7A0E320

# Multiblindo Smart

## Accessories

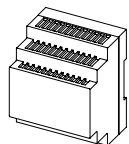

**POWER SUPPLY UNIT 24VDC - 70W**

Input 120-230Vac. Output 24Vdc 3A.  
DIN35 rail mounting.

Package: 1 Power Supply, instruction manual

1 5E3502



**FLEXIBLE CABLE FOR RIM MOUNTING, EXTERNAL**

Length 300 mm, for opening up to 180°

1 94403010E

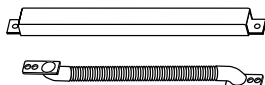

**FLEXIBLE CABLE FOR RIM MOUNTING, EXTERNAL**

Length 290 mm, for opening up to 90°

1 94403110E

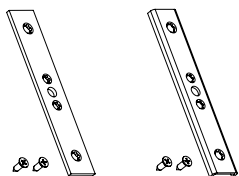

**STAINLESS STEEL PLATE FOR MAGNET HOLDER**

with flat front plate - dimensions 24X3mm

1 033103

with U-shaped front plate - dimensions 24X6mm

1 033104

# x1R Smart 2.0



## Control for security doors

X1R SMART is a motorised electronic lock specifically designed for security doors. It combines the solidity of a mechanical lock with the versatility of electronic control via smartphone, RFID tag or keypad.

## Choose your preferred credential

The security doors equipped with x1R Smart lock offer to the user the possibility of accessing with the Argo app from a Smartphone and with RFID devices. It is also possible to have a numeric keypad and fingerprint reader on the door, to allow access to the user without having to use any physical credentials.

## Product's functions

- Opening via PIN code and finger print.
- Motorised opening and closing of deadbolts and latchbolt.
- Quick opening from inside the room with "Single Action" handle (optional).
- Opening via European profile cylinder (EN1303, DIN 18252).
- Light function (latch only) programmable by the user for certain days and time slots.
- Memorize up to 300 users credentials
- Records the last 1000 events
- Battery-operated device with charge status detection
- Wake up by RFID card detection or phone Bluetooth® (patented)
- Low energy consumption device
- Real Time Clock/Calendar
- Light and acoustic signals
- Permanently open mode (office mode) without no extra battery consumption
- Block the Standard Users allowing access only to VIP users
- Programming and software updates by Argo app on iOS and Android devices

## ENVIRONMENTAL CHARACTERISTICS

- IP44

## CREDENTIALS

- Apple Watch
- Badge
- Bracelet
- Numeric Keypad
- Fingerprint
- Keyfob
- Smartphone

## COMMUNICATION INTERFACE

- Check the communication interfaces of X1R-compatible readers

## CERTIFICATIONS

- EN 14846:2008 with the classification |3|X|9|E|0|P|7|1|1|3|

Go to page

## MODELS

- Rim version p. 88
- Rim version Single Action with quick release via the handle p. 89
- Mortice version p. 90
- Mortice version Single Action with quick release via the handle p. 91
- Panic 4RM Motorized and anti-panic lock for armoured doors - Rim version p. 92

# x1R Smart 2.0

## Selection guide

x1R Smart is a motorised electronic lock specially designed for application on armoured doors.

It combines the robustness of a mechanical lock with the versatility of electronic control via Smartphone, RFID tag or keypad.

### ORDER THE PRODUCT IN A FEW STEPS

1

Check the type and dimensions of the x1R Smart lock.

3

Choose the **control module** and **accessories best** suited to your needs.

Choose from menu

[Control modules](#)

[Other accessories](#)

2

Choose the model of the x1R Smart in the column on the right.

4

**Optional.**  
Choose accessories to complete the system.

Go to page

## SELECTION GUIDE

### MODELS

- Rim version p. 88
- Rim version Single Action with quick release via the handle p. 89
- Mortice version p. 90
- Mortice version Single Action with quick release via the handle p. 91
- Panic 4RM Motorized and anti-panic lock for armoured doors - Rim version p. 92

## x1R Smart 2.0 Rim version

### MOTORIZED ELECTRONIC LOCK SPECIFICALLY DESIGNED FOR SECURITY DOORS, RIM VERSION

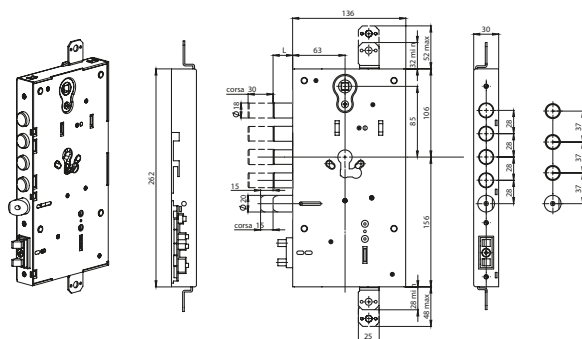

Click on the product code to download the right datasheet

4 DEADBOLTS. Projection 3. Centre distance 28	<a href="#">0006960328550</a>
4 DEADBOLTS. Projection 13. Centre distance 28	<a href="#">0006961328550</a>
3 DEADBOLTS. Projection 3. Centre distance 37	<a href="#">0006960337550</a>
3 DEADBOLTS. Projection 13. Centre distance 37	<a href="#">0006961337550</a>

 Accessories

#### DIMENSIONS

Deadbolts in chrome-plated steel  $\varnothing$  18 mm, projection 30 mm  
Reversible latchbolt  $\varnothing$  20 mm, adjustable projection.  
Handle follower 8 mm for latchbolt operation.

### Technical features

**FIRMWARE**  
ARGO

**RELEASE**  
2.0

**POWER UNIT**  
Battery operated with 6 1.5 VDC alkaline batteries  
Power supply from 8 to 30 VDC 30W  
Consumption at rest 0.05A – Maximum (forced) 2.5A

**ESTIMATED BATTERY LIFE**  
Up to 3 years, up to 30.000 opening.  
The figure is dependent on the mode and environment of use and the options activated.

**PRODUCT COMPATIBILITY**

- Top and bottom attachments for rods for additional closures.
- Set up for M6 passing screws for cylinder protection fixing.
- Reversible door sensor with adjustable projection, including alignment device.
- Rim fixing with 4 passing screws or screw nuts.
- Inox version on request.

**MOUNTING**  
- On armored door

#### ONLINE CONTENT

 Web page

 Data sheet

 Leaflet

 User manual

 Installation guide

 Specifications

**ENVIRONMENTAL FEATURES**  
- IP44

**WORKING TEMPERATURE**  
-20°C ÷ +70°C

**STORAGE TEMPERATURE**  
-25°C ÷ +75°C

**PACKAGE**  
Lock, door sensor, cylinder fixing screws, assembly instructions

**ACCESSORIES (NOT INCLUDED)**

- Smart Readers for x1R
- Power supply
- Concealed lead cover

 Door entry system solution with x1R Smart lock and IS9100 automatic door operator.



## x1R Smart 2.0 Rim version Single Action with quick release via the handle

### MOTORIZED ELECTRONIC LOCK SPECIFICALLY DESIGNED FOR SECURITY DOORS, RIM VERSION SINGLE ACTION

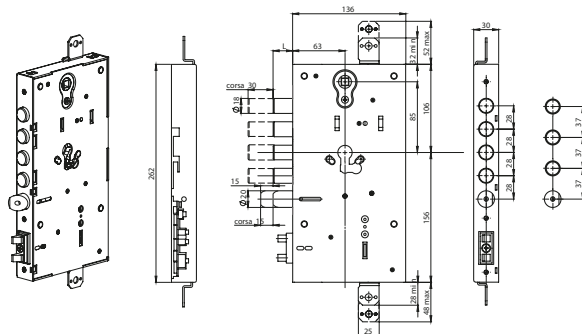

Click on the product code to download the right datasheet

4 DEADBOLTS. Projection 3. Centre distance 28.	<a href="#">0006990328550</a>
4 DEADBOLTS. Projection 13. Centre distance 28	<a href="#">0006991328550</a>
3 DEADBOLTS. Projection 3. Centre distance 37	<a href="#">0006990337550</a>
3 DEADBOLTS. Projection 13. Centre distance 37	<a href="#">0006991337550</a>

 Accessories

#### DIMENSIONS

Deadbolts in chrome-plated steel  $\varnothing$  18 mm, projection 30 mm  
Reversible latchbolt  $\varnothing$  20 mm, adjustable projection.  
Handle follower 8 mm for latchbolt operation.

### Technical features

**FIRMWARE**  
ARGO

**RELEASE**  
2.0

**POWER UNIT**  
Battery operated with 6 1.5 VDC alkaline batteries  
Power supply from 8 to 30 VDC 30W  
Consumption at rest 0.05A – Maximum (forced) 2.5A

**ESTIMATED BATTERY LIFE**  
Up to 3 years, up to 30.000 opening.  
The figure is dependent on the mode and environment of use and the options activated.

**PRODUCT COMPATIBILITY**

- Top and bottom attachments for rods for additional closures.
- Set up for M6 passing screws for cylinder protection fixing.
- Reversible door sensor with adjustable projection, including alignment device.
- Rim fixing with 4 passing screws or screw nuts.
- Inox version on request.

**MOUNTING**  
- On armored door

#### ONLINE CONTENT

 Web page

 Data sheet

 Leaflet

 User manual

 Installation guide

 Specifications

**ENVIRONMENTAL FEATURES**  
- IP44

**WORKING TEMPERATURE**  
-20°C ÷ +70°C

**STORAGE TEMPERATURE**  
-25°C ÷ +75°C

**PACKAGE**  
Lock, door sensor, cylinder fixing screws, assembly instructions

**ACCESSORIES (NOT INCLUDED)**

- Smart Readers for x1R
- Power supply
- Concealed lead cover

 Door entry system solution with x1R Smart lock and IS9100 automatic door operator.

## x1R Smart 2.0 Mortice version

### MOTORIZED ELECTRONIC LOCK SPECIFICALLY DESIGNED FOR SECURITY DOORS, MORTICE VERSION

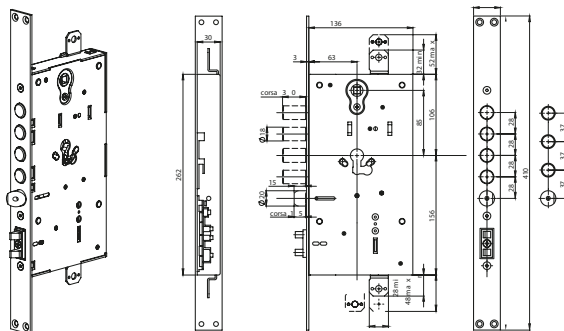

Click on the product code to download the right datasheet

4 DEADBOLTS. Centre distance 28 **0006960028550**

3 DEADBOLTS. Centre distance 37 **0006960037550**



#### DIMENSIONS

Deadbolts in chrome-plated steel  $\varnothing$  18 mm, projection 30 mm  
 Reversible latch  $\varnothing$  20 mm, adjustable projection.  
 Handle follower 8 mm for latchbolt operation.

### Technical features

**FIRMWARE**  
ARGO

**RELEASE**  
2.0

**POWER UNIT**  
 Battery operated with 6 1.5 VDC alkaline batteries  
 Power supply from 8 to 30 VDC 30W  
 Consumption at rest 0.05A – Maximum (forced) 2.5A

**ESTIMATED BATTERY LIFE**  
 Up to 3 years, up to 30.000 opening.  
 The figure is dependent on the mode and environment of use and the options activated.

**PRODUCT COMPATIBILITY**

- Top and bottom attachments for rods for additional closures.
- Set up for M6 passing screws for cylinder protection fixing.
- Reversible door sensor with adjustable projection, including alignment device.
- Mortice fixing with front plate in chrome-plated steel mm 410x35x3.
- Inox version on request.

**MOUNTING**  
- On armored door

#### ONLINE CONTENT

 Web page

 Data sheet

 Leaflet

 User manual

 Installation guide

 Specifications

**ENVIRONMENTAL FEATURES**  
- IP44

**WORKING TEMPERATURE**  
-20°C ÷ +70°C

**STORAGE TEMPERATURE**  
-25°C ÷ +75°C

**PACKAGE**  
Lock, door sensor, cylinder fixing screws, assembly instructions.

**ACCESSORIES (NOT INCLUDED)**

- Smart Readers for x1R
- Power supply
- Concealed lead cover

 Door entry system solution with x1R Smart lock and IS9100 automatic door operator.

## x1R Smart 2.0 Mortice version Single Action with quick release via the handle

MOTORIZED ELECTRONIC LOCK SPECIFICALLY  
DESIGNED FOR SECURITY DOORS,  
MORTICE VERSION SINGLE ACTION

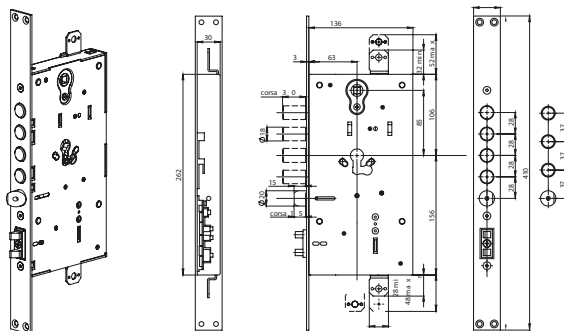

Click on the product code to download the right datasheet

4 DEADBOLTS. Centre distance 28      **0006990028550**

3 DEADBOLTS. Centre distance 37      **0006990037550**

 Accessories

### DIMENSIONS

Deadbolts in chrome-plated steel  $\varnothing$  18 mm, projection 30 mm  
Reversible latch  $\varnothing$  20 mm, adjustable projection.  
Handle follower 8 mm for latchbolt operation.

### Technical features

**FIRMWARE**  
ARGO

**RELEASE**  
2.0

**POWER UNIT**  
Battery operated with 6 1.5 VDC alkaline batteries  
Power supply from 8 to 30 VDC 30W  
Consumption at rest 0.05A – Maximum (forced) 2.5A

**ESTIMATED BATTERY LIFE**  
Up to 3 years, up to 30.000 opening.  
The figure is dependent on the mode and environment of use and the options activated.

**PRODUCT COMPATIBILITY**

- Top and bottom attachments for rods for additional closures.
- Set up for M6 passing screws for cylinder protection fixing.
- Reversible door sensor with adjustable projection, including alignment device.
- Mortice fixing with front plate in chrome-plated steel mm 410x35x3.
- Inox version on request.

**MOUNTING**  
- On armored door

### ONLINE CONTENT

 Web page

 Data sheet

 Leaflet

 User manual

 Installation guide

 Specifications

**ENVIRONMENTAL FEATURES**  
- IP44

**WORKING TEMPERATURE**  
-20°C ÷ +70°C

**STORAGE TEMPERATURE**  
-25°C ÷ +75°C

**PACKAGE**  
Lock, door sensor, cylinder fixing screws, assembly instructions.

**ACCESSORIES (NOT INCLUDED)**

- Smart Readers for x1R
- Power supply
- Concealed lead cover

 Door entry system solution with x1R Smart lock and IS9100 automatic door operator.

## x1R Smart 2.0 Panic 4RM Motorized and anti-panic lock for armoured doors - Rim version

MOTORISED ELECTRONIC LOCK SPECIFICALLY DESIGNED FOR SECURITY DOORS WITH ANTI-PANIC OR EMERGENCY FUNCTION, RIM VERSION

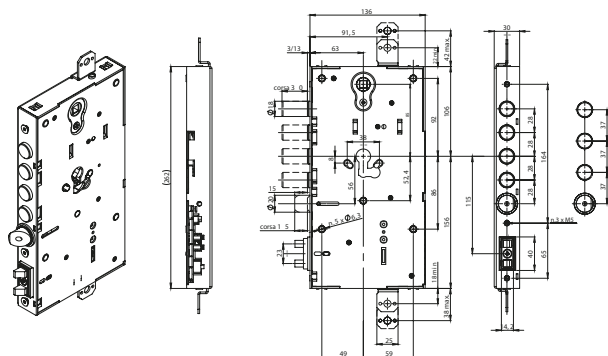

Click on the product code to download the right datasheet

4 DEADBOLTS, protrusion 3, centre distances 28	<a href="#">00069H0328550</a>
4 DEADBOLTS, protrusion 13, centre distances 28	<a href="#">00069H1328550</a>
3 DEADBOLTS, protrusion 3, centre distances 37	<a href="#">00069H0337550</a>
3 DEADBOLTS, protrusion 13, centre distances 37	<a href="#">00069H1337550</a>

 Accessories

### DIMENSIONS

Deadbolt in chromed steel diam. 18 mm, stroke 30 mm  
Reversible latch diam. 20 mm, adjustable protrusion  
Square spindle 8 mm.

### Technical features

**FIRMWARE**  
ARGO

**RELEASE**  
2.0

**POWER UNIT**  
Battery operated with 6 1.5 VDC alkaline batteries  
Power supply from 8 to 30 VDC 30W  
Consumption at rest 0.05A – Maximum (forced) 2.5A

**ESTIMATED BATTERY LIFE**  
Up to 3 years, up to 30.000 opening.  
The figure is dependent on the mode and environment of use and the options activated.

**PRODUCT COMPATIBILITY**

- Top and bottom attachments for rods for additional closures.
- Set up for M6 passing screws for cylinder protection fixing.
- Reversible door sensor with adjustable projection, including alignment device.
- Suitable for fire-resistant doors

**MOUNTING**  
- On armored door

### ONLINE CONTENT

 Web page

 Data sheet

 Leaflet

 User manual

 Installation guide

 Specifications

**ENVIRONMENTAL FEATURES**  
- IP44

**WORKING TEMPERATURE**  
-20°C ÷ +70°C

**STORAGE TEMPERATURE**  
-25°C ÷ +75°C

**PACKAGE**  
Lock, leaf approach contact, strike plate, cylinder fixing screws, instructions

**ACCESSORIES (NOT INCLUDED)**

- Smart Readers for x1R
- Power supply
- Concealed lead cover

## x1R Smart 2.0

### Accessories

### CONTROL MODULES (1/3)



#### MULTI-READER

Compatible with X1R SMART.

Includes black cover and 3 connection cables L 1 mt.

Numeric keyboard, RFID reader 13,56 Mhz, Bluetooth®

“Wake on Hand” technology. Encrypted data communication protocol.

1 0000098108696



#### MULTI-READER WITH FINGERPRINT

Compatible with X1R SMART.

Includes black cover and 3 connection cables L 1 mt.

Numeric keyboard, RFID reader 13,56 Mhz, biometric reader, Bluetooth®

“Wake on Hand” technology. Encrypted data communication protocol.

1 0000098109696



#### EXTERNAL CONTROL MODULE WITH RFID READER 13.56 MHZ AND BLUETOOTH®.

Compatible with X1R SMART, includes pair of connection cables L 100 cm.

Encrypted data communication protocol.

1 0000098105696



#### EXTERNAL CONTROL MODULE WITH KEYBOARD,

RFID READER 13,56 MHZ AND BLUETOOTH® LE

compatible with X1R SMART includes pair of connection cables L 100 cm

Encrypted data communication protocol.

1 0000098111696

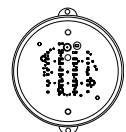

Hidden RFID reader and Bluetooth®. Compatible with X1R Smart.

Includes pair of connection cables L 100 cm

1 0000098106696

## x1R Smart 2.0

### Accessories

### CONTROL MODULES (2/3)

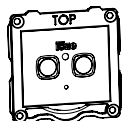

SQUARE INTERNAL CONTROL MODULE WITH 2 BUTTONS  
Compatible with X1R SMART, includes connection cable L 60 cm.  
Encrypted data communication protocol.

1 0000098PI2696



2-BUTTON INTERNAL CONTROL MODULE  
Compatible with X1R SMART, includes connection cable L 60 cm.  
Encrypted data communication protocol.

1 0000098PI0696

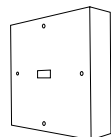

METAL BOX FOR HIDDEN READER  
Measure: 104 x 32 x 104 mm (L x W x H)

1 0000098NBM696

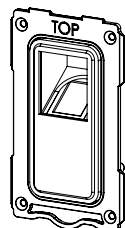

EMBEDDED FLUSH FINGERPRINT READER  
Compatible with X1R SMART. Includes pair of connection cables L 100 cm  
Encrypted data communication protocol.  
Required thickness inside the door 26 mm.

1 5E62100

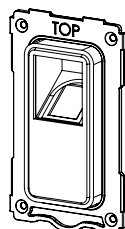

EMBEDDED PROTRUDING FINGERPRINT READER  
Compatible with X1R SMART. Includes pair of connection cables L 100 cm  
Encrypted data communication protocol.  
Required thickness inside the door 19 mm.

1 5E63100

## x1R Smart 2.0

### Accessories

### CONTROL MODULES (3/3)

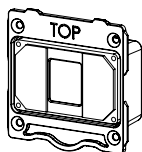

#### SURFACE MOUNTED FINGERPRINT READER

Compatible with X1R SMART. Includes pair of connection cables L 100 cm

Encrypted data communication protocol.

Required thickness inside the door 15 mm.

1 5E62200

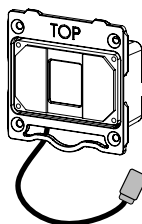

#### IP66 SURFACE MOUNTED FINGERPRINT READER

Compatible with X1R SMART with embedded cable and IP66 connector.

Encrypted data communication protocol.

Required thickness inside the door 15 mm.

1 5E62220

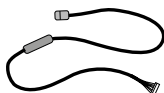

#### IP66 CABLE FOR FINGERPRINT READER L 1.2 mt.

Connection cable between IP66 surface mounted fingerprint reader and X1R Smart

1 0000IS00246

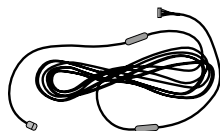

#### IP66 CABLE FOR FINGERPRINT READER L 10 mt.

Connection cable between IP66 surface mounted fingerprint reader and X1R Smart 1

1 0000IS00247

## x1R Smart 2.0

### Accessories

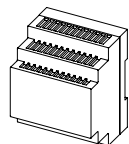

POWER SUPPLY UNIT 24Vdc - 30W  
Input 120-230Vac. Output 24Vdc 1.2A.  
DIN35 rail mounting.

Package: 1 power supply unit, instruction manual.

1 5E3506

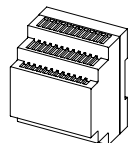

POWER SUPPLY UNIT 12Vdc - 70W  
Input 120-230Vac. Output 12Vdc 3A.  
DIN35 rail mounting.

Package: 1 power supply unit, instruction manual.

1 5E3509

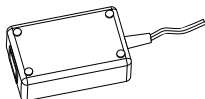

POWER SUPPLY UNIT 9V DC - 4 A for direct power.  
Compatible with X1R SMART. Connection cable to X1R Smart NOT INCLUDED,  
to be ordered separately by code 0000098MP0696  
(8-POLE MULTIFUNCTION CONNECTION CABLE)

1 5E3507



CONCEALED LEAD COVER, flexible, external, L=300.  
For openings up to 180°.

1 94403010E

CONCEALER LEAD COVER external, flush version L=300

1 94403110E

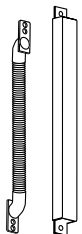

CONCELEAD LEAD COVER, flexible, flush version L=260.  
For openings up to 90°.  
Compatible con Thesis, Top Exit DGT, X1R.

1 00000881000000



SPRING CONCELEAD LEAD COVER, flexible L=68.  
For openings up to 180°.

1 0000060130000



## x1R Smart 2.0

### Accessories

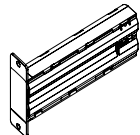

BATTERY HOLDER in black nylon for 6 D-type batteries  
Compatible with X1R SMART supplied with bipolar connection  
cable L 240 cm. (batteries not provided).

Black	1	5820069600005
Grey	1	5820069600015
White	1	5820069600025



6 D-TYPE BATTERIES 1.5V

ALKALINE	1	5820060000006
----------	---	---------------

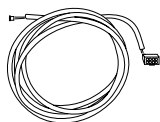

BIPOLAR CONNECTION CABLE FOR REMOTE CONTROL  
L 450 cm compatible with X1R SMART.

	1	0000098CR0696
--	---	---------------

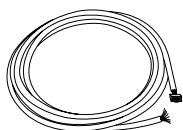

8-POLE MULTIFUNCTION CONNECTION CABLE L 450 CM FOR REMOTE CONTROL,  
DOOR STATUS, DIRECT POWER AND LOCKBUS COMMUNICATION  
Compatible with X1R Smart.

	1	0000098MP0696
--	---	---------------

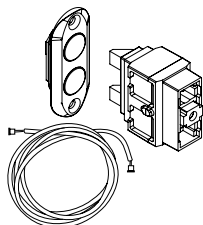

ADJUSTABLE DOOR CONTACT KIT FOR REMOTE CONTROL  
Includes bipolar connection cable L 200 cm and door contact.  
Compatible with X1R SMART.

	1	0000098MO2170
--	---	---------------

## x1R Smart 2.0

### Accessories

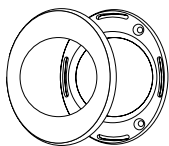

Universal single escutcheons made of a nylon base, brass cover and fixing screw.

Compatible with: \*98PI0698, \*98TE0698 e \*98PE0698.

BRONZE PLATED	1	0000098N0XBRO
POLISHED CHROME	1	0000098N0XCRL
SATIN CHROME	1	0000098N0XCRS
POLISHED BRASS VARNISHED	1	0000098N0XOLV
BRONZE PLATED	10	0000098N1DBRO
POLISHED CHROME	10	0000098N1DCRL
SATIN CHROME	10	0000098N1DCRS
POLISHED BRASS VARNISHED	10	0000098N1DOLV

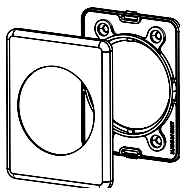

Universal rectangular single escutcheons made of a nylon base, brass cover and fixing screw.

Compatible with: all readers and round inserts code \*98PI0698, \*98TE0698 e \*98PE0698.

BRONZE PLATED	1	0000098N2XBRO
POLISHED CHROME	1	0000098N2XCRL
SATIN CHROME	1	0000098N2XCRS
POLISHED BRASS VARNISHED	1	0000098N2XOLV
BRONZE PLATED	10	0000098N2DBRO
POLISHED CHROME	10	0000098N2DCRL
SATIN CHROME	10	0000098N2DCRS
POLISHED BRASS VARNISHED	10	0000098N2DOLV

## x1R Smart 2.0

### Accessories

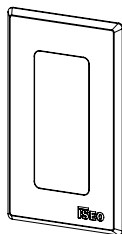

Cover for EMBEDDED FLUSH FINGERPRINT READER

Compatible with: 5E62100

POLISHED BLACK	1	5E621105
SATIN CHROME	1	5E62110Y
POLISHED BRASS	1	5E62110L

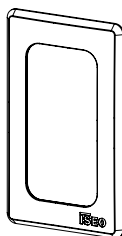

Cover for EMBEDDED PROTRUDING FINGERPRINT READER

Compatible with: 5E63100

POLISHED BLACK	1	5E631105
SATIN CHROME	1	5E63110Y
POLISHED BRASS	1	5E63110L

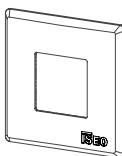

Cover for SURFACE MOUNTED FINGERPRINT READER

Compatible with: 5E62200

POLISHED BLACK	1	5E622105
SATIN CHROME	1	5E62210Y
POLISHED BRASS	1	5E62210L

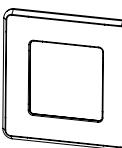

Square cover for 2-button internal control module.

Only compatible square 2-button internal control module code 000008PI2696

POLISHED BLACK	1	0000098CPI005
SATIN CHROME	1	0000098CPI00Y
POLISHED BRASS	1	0000098CPI00L
BRONZE	1	0000098CPI00B

# Smart Gateway



## Control the system remotely

With Smart Gateway, the ARGO system by ISEO can be controlled remotely, in residential but also in 'light' commercial environments, such as shops, small offices, B&Bs, where the new smart devices generation for door locks it can simplify your daily life and make logistics easier.

## Connection security

The Argo 3.0 system guarantees a secure connection thanks to Bluetooth® Low Energy 5.1 and end-to-end encryption, which manages communication without an intermediate server.

## COLOR

White

## COMMUNICATION INTERFACE

- Conversion from WIFI data to Bluetooth®
- Dual Band WIFI at 2.4 GHz and 5 GHz
- USB type C

Go to page

## MODELS

- WIFI p. 102
- Power over Ethernet p. 103

# Smart Gateway

## Selection guide

Smart Gateway connects the cloud platform (Argo account of ISEO) to the door lock. The device communicates with the cloud via the data connection and to the door lock via Bluetooth® Low Energy 5.1.

Smart Gateway can manage all door locks within the Bluetooth® operating radius (approx. 10 metres, depending on environmental conditions).

The Smart Gateway is available in two versions to adapt to different installation requirements.

## ORDER THE PRODUCT IN A FEW STEPS

1

Choose the appropriate template for your application and click in the column on the right :

### WiFi Smart Gateway

Device used for installations where it is preferred to use the WiFi network to connect the system to the Internet (residential market).

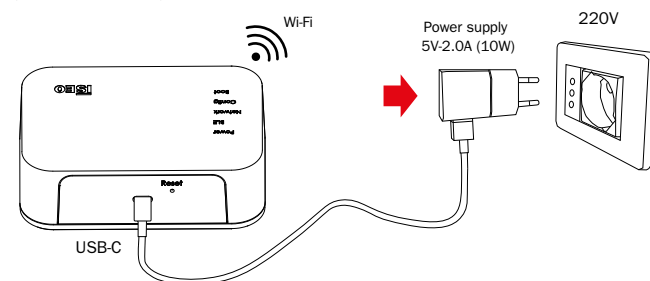

### PoE Smart Gateway

To be used if the WiFi network is not present or has usage restrictions (tertiary/commercial market). The Ethernet connection can also be used as a power supply for the device (Power over Ethernet).

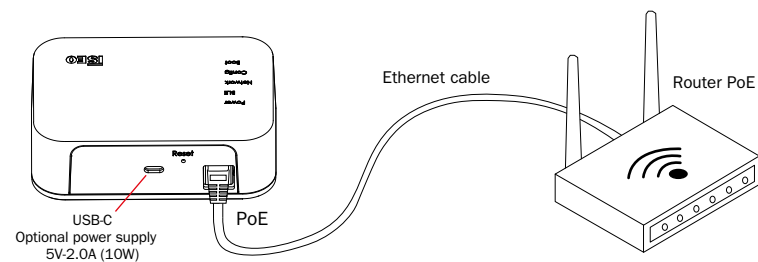

2

### Optional.

Choose accessories to complete the system

Go to page

● SELECTION GUIDE

## MODELS

→ WIFI p. 102

→ Power over Ethernet p. 103

## Smart Gateway WIFI

IT ALLOWS YOU TO MANAGE YOUR ARGO SYSTEM FROM REMOTE WITHOUT CABLED IP CONNECTIONS

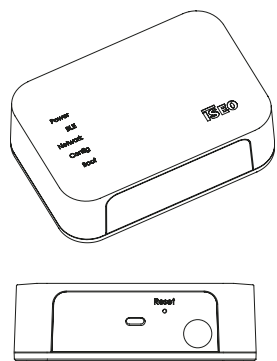

### Technical features

**FIRMWARE**  
ARGO

**POWER UNIT**  
Powered by USB C +5VDC input power 2A (10W).  
Power supply not included (accessory to order separately).

**HARDWARE SPECIFICATIONS**

- ARM A7 based CPU module
- 512 MB RAM
- 8 GB Flash eMMC Non volatile Memory

**MOUNTING**

- Desktop
- Wall mounted

**WORKING TEMPERATURE**  
0°C ÷ +50°C

**STORAGE TEMPERATURE**  
-25°C ÷ +75°C

**PACKAGE**  
1 Smart Gateway WIFI  
Power supply not included (accessory to order)

**ACCESSORIES (NOT INCLUDED)**

- Power supply (cod. 0000A00155)
- Wall fixing brackets kit (cod. 0000A00154)



code 5E075524

 Accessories

### DIMENSIONS

- Width: 125mm
- Depth: 40mm
- Height: 85mm

### ONLINE CONTENT

-  Web page
-  Installation guide
-  Data sheet
-  Specifications
-  User manual

## Smart Gateway Power over Ethernet

### CONNECT THE ARGO SYSTEM TO THE INTERNET VIA AN ETHERNET CABLE

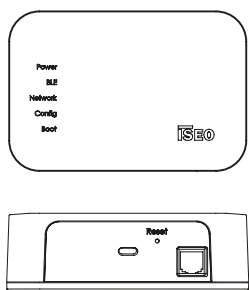

### Technical features

#### FIRMWARE

ARGO

#### POWER UNIT

Requires PoE Switch IEEE 802.3af up to 15,4W.  
 Delivery of data and power over CAT5e/CAT6 ethernet cable.  
 Maximum power consumption 10W.

#### HARDWARE SPECIFICATIONS

- ARM A7 based CPU module
- 512 MB RAM
- 8 GB Flash eMMC Non volatile Memory

#### MOUNTING

- Desktop
- Wall mounted

#### WORKING TEMPERATURE

0°C ÷ +50°C

#### STORAGE TEMPERATURE

-25°C ÷ +75°C

#### PACKAGE

1 Smart Gateway PoE

#### ACCESSORIES (NOT INCLUDED)

- Power supply (cod. 0000A00155)
- Wall fixing brackets kit (cod. 0000A00154)

code 5E075514



#### DIMENSIONS

- Width: 125mm
- Depth: 40mm
- Height: 85mm

#### ONLINE CONTENT

 Web page

 Data sheet

 User manual

 Installation guide

 Specifications

## Smart Gateway

### Accessories

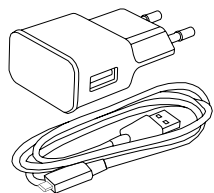

**POWER SUPPLY**  
 IN = 100-240V50-60Hz 0.50A  
 OUT = 5.0Vdc 2A (10W)  
 USB A to USB C 1.5 mt cable

1 0000A00155

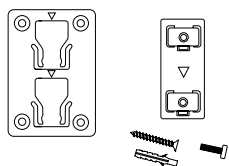

**WALL FIXING KIT**  
 nr. 1 Wall bracket  
 nr. 1 Gateway bracket  
 nr. 2 Screws  
 nr. 4 Wall plugs and screws

1 0000A00154



# Argo Cards

---

## MASTER CARD SET.

3 cards (#1, #2, #3 the next Master automatically cancels the previous one).

Package: 3 cards, instructions.

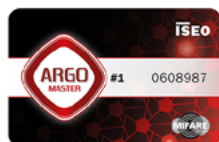

DESFire EV2

With ISEO logo

1

5E405309.3

---

## USER CARDS



DESFire EV2

With ISEO logo and UID

1

5E405301

---



MIFARE CLASSIC

With ISEO logo and UID

10

5E402001.A

---

Blank on both sides

10

5E402011

---

## Argo Keyfob and bracelet

---

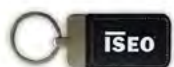

### USER KEYFOB

Leather-like Keyfob DESFire EV2  
With ISEO logo and UID

1 5E425301

---



Black ABS Keyfob DESFire EV2  
With ISEO logo and UID

2 5E415101

---



MIFARE CLASSIC  
With ISEO logo and UID

4 KEYFOB1356MF1

---



Silicone Wristband DESFire EV3  
With ISEO logo and UID - Not suitable to be used with X1R Smart  
Hidden RFID Reader

2 5E435101

---

# Code configurator

Some products are available in different versions to suit customer requirements and the characteristics of the doors on which they are to be installed.

Please use the configurator of the specific product model to create the code you wish to order.

## Aries Smart 2.0

[Go to page](#)

- Standard p. 108
- For panic devices p. 109
- For custom handles p. 110
- For custom handles, for panic devices p. 111
- For DIN lock p. 112
- For fire locks p. 113
- For Premi Apri Meroni locks p. 114

## Libra LE60 Smart 2.1

[Go to page](#)

- Standard p. 115
- Premium p. 116
- Half p. 117
- Double p. 118
- Removable reader and Extension plug 16 mm p. 119
- Removable reader and Extension plug 75 mm p. 120
- Dummy-knob p. 121
- Oval Australian p. 122
- Oval Scandinavian p. 123

## Multiblindo Smart

[Go to page](#)

- Standard p. 124



## Aries Smart 2.0 For panic devices

### ELECTRONIC TRIM RFID/BLUETOOTH® SET FOR PANIC DEVICES

### CODE CONFIGURATOR

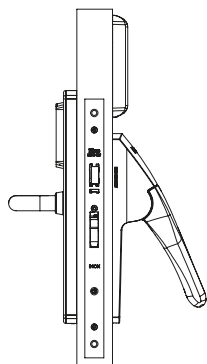

0 0 E 1    1 5 5

- Without cylinder hole in the cover 1
  - VISIBLE cylinder hole - center distance 85 mm 2
  - VISIBLE cylinder hole - center distance 92 mm 3
  - VISIBLE cylinder hole - center distance 70 mm 4
  - VISIBLE cylinder hole - center distance 72 mm 5
  - VISIBLE cylinder hole - center distance 88 mm 6
- 
- Internal usage version (IP54) 2
  - External usage version (IP55) 6
- 
- FINISHES
    - 2 Inox
- 
- 2 Electric emergency – without privacy \*
  - 4 Mechanical emergency – without privacy

\* ONLY compatible to configuration  
 Without cylinder hole in the cover  
 (code 1 in fifth position)

### Product options

#### OVERRIDE CYLINDER HOLE EXTERNAL SIDE

#### IP RATING

#### EMERGENCY OVERRIDE CYLINDER

#### EXTERNAL EMERGENCY POWER SUPPLY

To chose if a mechanical emergency cylinder is used. The mechanical cylinder is still accessible without cylinder hole, by turning the plate.

For internal (IP54) or external (IP55) usage.

High Security Iseo R90 Factory Monoprofile. Up to 3 mechanical recordings. Usage detected by electronics. KA on the same installation.

For installations with no override cylinder. Connector under external cover plate. Standard 9V battery usage.

## Aries Smart 2.0 For custom handles

### ELECTRONIC TRIM RFID/BLUETOOTH® SET FOR CUSTOM HANDLES

### CODE CONFIGURATOR

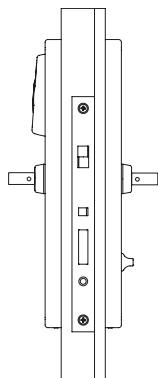

0 0 E 2    1 5 5   I

- Without cylinder hole in the cover 1
  - VISIBLE cylinder hole - center distance 85 mm 2
  - VISIBLE cylinder hole - center distance 92 mm 3
  - VISIBLE cylinder hole - center distance 70 mm 4
  - VISIBLE cylinder hole - center distance 72 mm 5
  - VISIBLE cylinder hole - center distance 88 mm 6
- 
- Internal usage version (IP54) 1
  - External usage version (IP55) 5
- 
- FINISHES
- 1 Electric emergency – with privacy \*
  - 2 Electric emergency – without privacy \*
  - 3 Mechanical emergency – with privacy
  - 4 Mechanical emergency – without privacy
- 
- I Industrial Packaging
  - 2 Inox

\* ONLY compatible to configuration  
Without cylinder hole in the cover  
(code 1 in fifth position)

### Product options

#### OVERRIDE CYLINDER HOLE EXTERNAL SIDE

#### IP RATING

#### EMERGENCY OVERRIDE CYLINDER

#### EXTERNAL EMERGENCY POWER SUPPLY

#### PRIVACY DEVICE

To chose if a mechanical emergency cylinder is used. The mechanical cylinder is still accessible without cylinder hole, by turning the plate.

For internal (IP54) or external (IP55) usage.

High Security Iseo R90 Factory Monoprofile. Up to 3 mechanical recordings. Usage detected by electronics. KA on the same installation.

For installations with no override cylinder. Connector under external cover plate. Standard 9V battery usage.

Internal ergonomic knob to activate privacy. Signal reset after each door opening.

## Aries Smart 2.0 For custom handles, for panic devices

### ELECTRONIC TRIM RFID/BLUETOOTH® SET FOR PANIC DEVICES

### CODE CONFIGURATOR

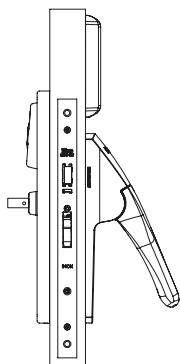

0 0 E 2    1 5 5   I

- Without cylinder hole in the cover 1
  - VISIBLE cylinder hole - center distance 85 mm 2
  - VISIBLE cylinder hole - center distance 92 mm 3
  - VISIBLE cylinder hole - center distance 70 mm 4
  - VISIBLE cylinder hole - center distance 72 mm 5
  - VISIBLE cylinder hole - center distance 88 mm 6
- 
- Internal usage version (IP54) 2
  - External usage version (IP55) 6
- 
- FINISHES
    - 1 Industrial Packaging
    - 2 Inox
  - 2 Electric emergency – without privacy \*
  - 4 Mechanical emergency – without privacy

\* ONLY compatible to configuration  
Without cylinder hole in the cover  
(code 1 in fifth position)

### Product options

#### OVERRIDE CYLINDER HOLE EXTERNAL SIDE

#### IP RATING

#### EMERGENCY OVERRIDE CYLINDER

#### EXTERNAL EMERGENCY POWER SUPPLY

To chose if a mechanical emergency cylinder is used. The mechanical cylinder is still accessible without cylinder hole, by turning the plate.

For internal (IP54) or external (IP55) usage.

High Security Iseo R90 Factory Monoprofile. Up to 3 mechanical recordings. Usage detected by electronics. KA on the same installation.

For installations with no override cylinder. Connector under external cover plate. Standard 9V battery usage.

# Aries Smart 2.0 For DIN lock

## ELECTRONIC TRIM RFID/BLUETOOTH® SET FOR DIN LOCK

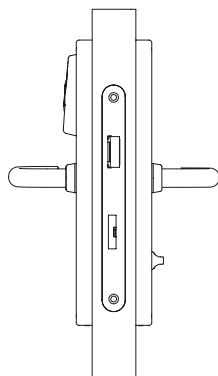

### CODE CONFIGURATOR

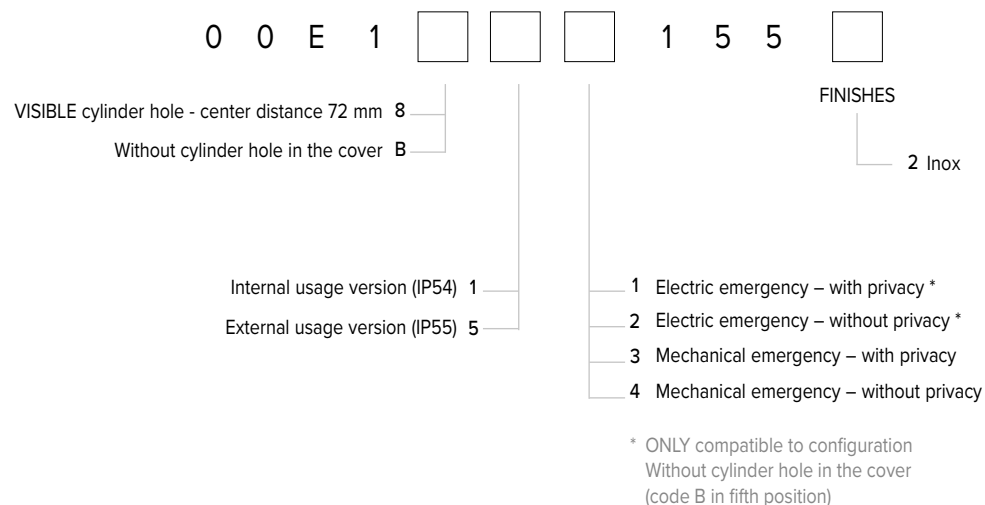

### Product options

OVERRIDE CYLINDER HOLE EXTERNAL SIDE	IP RATING	EMERGENCY OVERRIDE CYLINDER	EXTERNAL EMERGENCY POWER SUPPLY	PRIVACY DEVICE
To chose if a mechanical emergency cylinder is used. The mechanical cylinder is still accessible without cylinder hole, by turning the plate.	For internal (IP54) or external (IP55) usage.	High Security Iseo R90 Factory Monoprofile. Up to 3 mechanical recodings. Usage detected by electronics. KA on the same installation.	For installations with no override cylinder. Connector under external cover plate. Standard 9V battery usage.	Internal ergonomic knob to activate privacy. Signal reset after each door opening.



## Aries Smart 2.0 For fire locks

### ELECTRONIC TRIM RFID/BLUETOOTH® SET FOR FIRE LOCKS

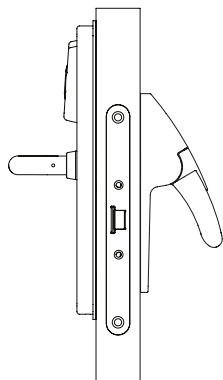

### CODE CONFIGURATOR

0 0 E 1 9  0 1 5 5

Internal usage version (IP54) 2  
 External usage version (IP55) 6

FINISHES  
 2 Inox

### Product options

#### IP RATING

For internal (IP54) or external (IP55) usage.

## Aries Smart 2.0 For Premi Apri Meroni locks

### ELECTRONIC TRIM RFID/BLUETOOTH® SET FOR PREMI APRI MERONI LOCKS

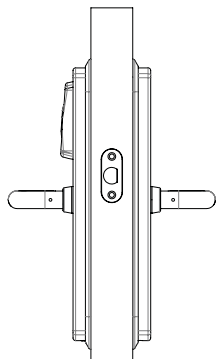

### CODE CONFIGURATOR

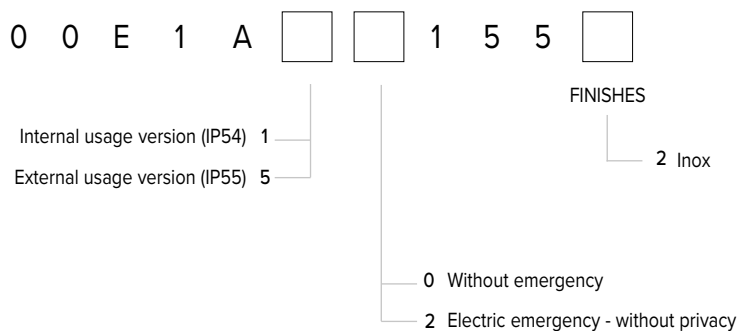

### Product options

IP RATING	EMERGENCY OVERRIDE CYLINDER	EXTERNAL EMERGENCY POWER SUPPLY	PRIVACY DEVICE
For internal (IP54) or external (IP55) usage.	High Security Iseo R90 Factory Monoprofile. Up to 3 mechanical recodings. Usage detected by electronics. KA on the same installation.	For installations with no override cylinder. Connector under external cover plate. Standard 9V battery usage.	Internal ergonomic knob to activate privacy. Signal reset after each door opening.

# Libra LE60 Smart 2.1 Standard

MODULAR CYLINDER WITH EXTERNAL RFID/BLUETOOTH® ELECTRONIC KNOB (FREE ROTATION) AND INTERNAL MECHANICAL KNOB (STANDARD TYPE)

## CODE CONFIGURATOR

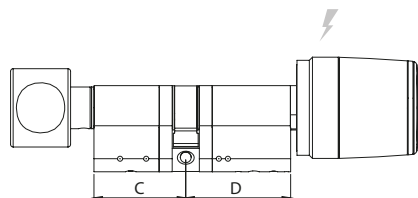

8	M	K	<input type="checkbox"/>	8	<input type="checkbox"/>	<input type="checkbox"/>	<input type="checkbox"/>	6	5	<input type="checkbox"/>
					DIMENSION C	DIMENSION D	FINISHES			P PANIC function ***/**
				Heavy Duty 1	30**/**	30				
				Standard 2	35	35				
				Removable external knob (Heavy Duty) **/**	40	40				
					45	45				
					50	50				
					55	55				
					60	60				
					65	65				
					70	70				
					75	75				
					...	...				
					...	...				
					130	130				
							25	Inox - Black		
							23	Inox - Metal Grey		
							L5	Polished Brass - Black*		
							K4	Polished Chrome - White		

L max 260 mm

\* not suitable for outdoor installations  
 \*\* not available Panic function version  
 \*\*\* not compatible with version "external removable knob"  
 \*\*\*\* L max 180 mm (L max per side 90 mm)

### Product options

#### HEAVY DUTY LIBRA KNOB

Version with drilling protection on the opening mechanism. IP rating IP66.

#### REMOVABLE EXTERNAL KNOB

Removable knob (Heavy Duty characteristics).

#### PANIC VERSION FOR PANIC LOCK

Freely rotating with cam returning in vertical position.

# Libra LE60 Smart 2.1 Premium

MODULAR CYLINDER WITH EXTERNAL ELECTRONIC RFID/BLUETOOTH® KNOB (FREE ROTATION) AND INTERNAL MECHANICAL KNOB (PREMIUM TYPE)

## CODE CONFIGURATOR

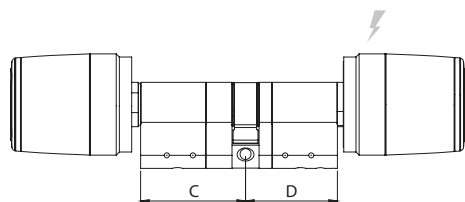

8 M K  0    6 5

	DIMENSION C	DIMENSION D	FINISHES
Heavy Duty 1	30**/***	30	25 Inox - Black 23 Inox - Metal Grey L5 Polished Brass - Black* K4 Polished Chrome - White
Standard 2	35	35	
Removable external knob (Heavy Duty) **/****	40	40	
	45	45	
	50	50	
	55	55	
	60	60	
	65	65	
	70	70	
	75	75	
	...	...	
	...	...	
	130	130	

L max 260 mm

P PANIC function \*\*\*/\*\*\*\*

### Product options

#### HEAVY DUTY LIBRA KNOB

Version with drilling protection on the opening mechanism. IP rating IP66.

#### REMOVABLE EXTERNAL KNOB

Removable knob (Heavy Duty characteristics).

#### PANIC VERSION FOR PANIC LOCK

Freely rotating with cam returning in vertical position.

\* not suitable for outdoor installations  
 \*\* not available Panic function version  
 \*\*\* not compatible with version "external removable knob"  
 \*\*\*\* L max 180 mm (L max per side 90 mm)

# Libra LE60 Smart 2.1 Half

MODULAR HALF KNOB CYLINDER  
WITH EXTERNAL ELECTRONIC RFID/BLUETOOTH®  
KNOB (FREE-ROTATING)

## CODE CONFIGURATOR

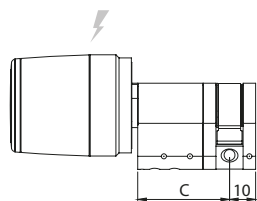

8 M K  0  1 0  6 5

	DIMENSION C	DIMENSION D	FINISHES
Heavy Duty 1	30 **		
Standard 2	35		
Removable external knob (Heavy Duty) ***	40		
	45		
	50		
	55		
	60		
	65		
	70		25 Inox - Black
	75		23 Inox - Metal Grey
	...		L5 Polished Brass - Black *
	...		K4 Polished Chrome - White
	180		

L max 190 mm

\* not suitable for outdoor installations  
 \*\* Libra monoprofile 30/10 removable reader is not modular. Length 35/10 and up is modular.  
 \*\*\* L max 90/10

### Product options

#### HEAVY DUTY LIBRA KNOB

Version with drilling protection on the opening mechanism. IP rating IP66.

#### REMOVABLE EXTERNAL KNOB

Removable knob (Heavy Duty characteristics).

# Libra LE60 Smart 2.1 Double

MODULAR CYLINDER WITH EXTERNAL ELECTRONIC RFID/BLUETOOTH® KNOB (FREE-ROTATING) AND INTERNAL ELECTRONIC KNOB (FREE-ROTATING)

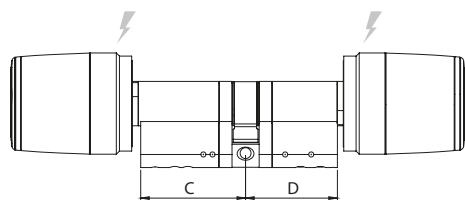

## CODE CONFIGURATOR

8 M K  E    6 5

	DIMENSION C	DIMENSION D	FINISHES
Heavy Duty 1		30	<input type="checkbox"/> 25 Inox - Black <input type="checkbox"/> 23 Inox - Metal Grey <input type="checkbox"/> L5 Polished Brass - Black * <input type="checkbox"/> K4 Polished Chrome - White
Standard 2	35	35	
	40	40	
	45	45	
	50	50	
	55	55	
	60	60	
	65	65	
	70	70	
	75	75	
	...	...	
	...	...	
	90	90	

L max 180 mm

\* not suitable for outdoor installations  
 \*\* C = side with removable electronic knob

## Product options

### HEAVY DUTY LIBRA KNOB

Version with drilling protection on the opening mechanism. IP rating IP66.

## Libra LE60 Smart 2.1 Removable reader and Extension plug 16 mm

MODULAR CYLINDER FOR ARMORED DOORS WITH EXTERNAL ELECTRONIC RFID/BLUETOOTH® KNOB (FREE ROTATION), COMPATIBLE WITH CYLINDERS ESCUTCHEON, EXTENSION PLUG AND PRE-ARRANGED FOR INTERNAL KNOB SHAFT D 8X16 MM

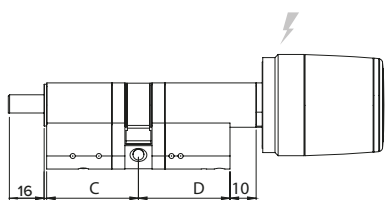

### CODE CONFIGURATOR

8 M K 3 6



6 5

DIMENSION

DIMENSION

FINISHES

C

D

30

30

35

35

40

40

45

45

50

50

55

55

60

60

70

70

...

...

...

...

90

85

L max 175 mm

- 25 Inox - Black
- 23 Inox - Metal Grey
- L5 Polished Brass - Black \*
- K4 Polished Chrome - White

\* not suitable for outdoor installations

### Product options

HEAVY DUTY  
LIBRA KNOB

Version with drilling protection on the opening mechanism. IP rating IP66.

## Libra LE60 Smart 2.1 Removable reader and Extension plug 75 mm

MODULAR CYLINDER FOR ARMORED DOORS WITH EXTERNAL ELECTRONIC RFID/BLUETOOTH® KNOB (FREE ROTATION), COMPATIBLE WITH CYLINDERS ESCUTCHEON, EXTENSION PLUG AND PRE-ARRANGED FOR INTERNAL KNOB SHAFT D 8X75 MM

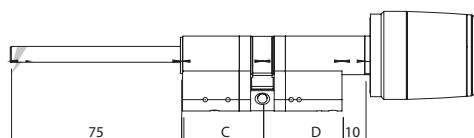

### CODE CONFIGURATOR

8 M K 3 6    D 0              6 5

DIMENSION  
C

DIMENSION  
D

FINISHES

- 30
- 35
- 40
- 45
- 50
- 55
- 60
- 70
- ...
- ...
- 85

- 25 Inox - Black
- 23 Inox - Metal Grey
- L5 Polished Brass - Black\*
- K4 Polished Chrome - White

L max 115 mm

\* not suitable for outdoor installations.

### Product options

#### HEAVY DUTY LIBRA KNOB

Version with drilling protection on the opening mechanism. IP rating IP66.



# Libra LE60 Smart 2.1 Dummy-knob

MODULAR CYLINDER FOR ARMORED DOORS WITH EXTERNAL ELECTRONIC RFID/BLUETOOTH® KNOB (FREE ROTATION) AND KNOB-DUMMY ON INTERNAL SIDE

## CODE CONFIGURATOR

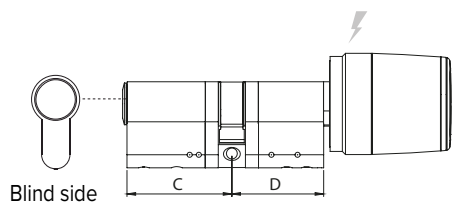

8 M K  C     6 5

	DIMENSION C	DIMENSION D	FINISHES
Heavy Duty 1	30 <sup>**/**</sup>	30	P PANIC function <sup>***/**</sup>  25 Inox - Black 23 Inox - Metal Grey L5 Polished Brass - Black * K4 Polished Chrome - White
Standard 2	35	35	
Removable external knob (Heavy Duty) <sup>**/**</sup>	40	40	
	45	45	
	50	50	
	55	55	
	60	60	
	65	65	
	70	70	
	75	75	
	...	...	
	...	...	
	130	130	

L max 260 mm

### Product options

#### HEAVY DUTY LIBRA KNOB

Version with drilling protection on the opening mechanism. IP rating IP66.

#### REMOVABLE EXTERNAL KNOB

Removable knob (Heavy Duty characteristics).

#### PANIC VERSION FOR PANIC LOCK

Freely rotating with cam returning in vertical position.

\* not suitable for outdoor installations  
 \*\* not available Panic function version  
 \*\*\* not compatible with version "external removable knob"  
 \*\*\*\* L max 180 mm (L max per side 90 mm)

## Libra LE60 Smart 2.1 Oval Australian

OVAL AUSTRALIAN ELECTRONIC CYLINDER WITH EXTERNAL RFID/BLUETOOTH® ELECTRONIC KNOB (FREE ROTATION)

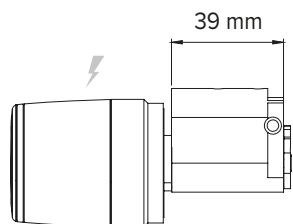

### CODE CONFIGURATOR

8 S K  9 0 0    6 5

- Heavy Duty 1
- Standard 2

DIMENSION  
39

FINISHES

- 25 Inox - Black
- 23 Inox - Metal Grey
- L5 Polished Brass - Black \*
- K4 Polished Chrome - White

\* not available for Heavy Duty version  
 delivery time on request

### Product options

#### HEAVY DUTY LIBRA KNOB

Version with drilling protection on the opening mechanism. IP rating IP66.

# Libra LE60 Smart 2.1 Oval Scandinavian

OVAL SCANDINAVIAN ELECTRONIC CYLINDER WITH EXTERNAL ELECTRONIC RFID/BLUETOOTH® KNOB (FREE ROTATION)

## CODE CONFIGURATOR

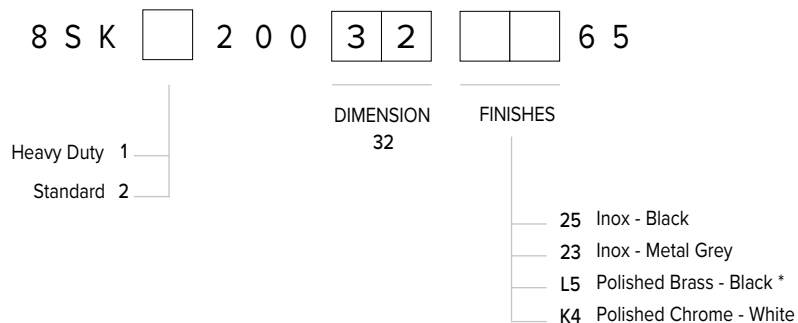
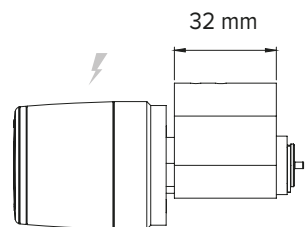

\* not available for Heavy Duty version  
delivery time on request

## Product options

HEAVY DUTY  
LIBRA KNOB

Version with drilling protection on the opening mechanism. IP rating IP66.

## Multiblindo Smart

MOTORIZED SELF-LOCKING MULTI-POINT LOCK,  
 WITH A HIGH LEVEL OF SECURITY, SUITABLE FOR  
 METAL FRAME DOORS MULTIPLE LOCKING POINTS,  
 TO BE COMBINED WITH CONNECTION BOX

### CODE CONFIGURATOR

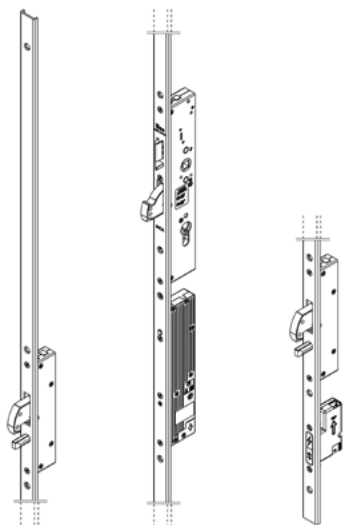

7 A 3 E     2 5

FRONT SHAPE

BACKSET

D Right  
S Left

U-shaped - stainless steel - 24x6x2300 mm 00

Flat front- stainless steel - 24x3x2300 mm 10

35  
40  
45  
50  
55  
60  
65

### Product options

#### FRONT SHAPE

Flat front 24X3 mm stainless steel.  
 U-shaped front 24X6 mm stainless steel.

#### BACKSET (mm)







Available in versions with  
 35,40,45,50,55,60,65 mm backset

#### RIGHT/LEFT





Right and left version  
 according to DIN 107.

## Phased out products

The table shows the replacement codes for phased out products. If no replacement code is available, please consult the catalogue to assess the right product solution.

Code	Product model	Title	Description	Substitution code	Go to page
8MKx8xxxxx55x	Libra LE60 Smart 2.0	Standard	Modular cylinder with external electronic knob (free rotation) and internal mechanical knob (standard type)	8MKx8xxxxx65x	<a href="#">→</a> 
8MKx0xxxxx55x	Libra LE60 Smart 2.0	Premium	Modular cylinder with external electronic knob (free rotation) and internal mechanical knob (premium type)	8MKx0xxxxx65x	<a href="#">→</a> 
8MKx0xx10xx55	Libra LE60 Smart 2.0	Half	Modular half knob cylinder with external electronic knob (free-rotating)	8MKx0xx10xx65	<a href="#">→</a> 
8MKxExxxxx55	Libra LE60 Smart 2.0	Double	Modular cylinder with external electronic knob (free-rotating) and internal electronic knob (free-rotating)	8MKxExxxxx65	<a href="#">→</a> 
8MK36xxxxx55	Libra LE60 Smart 2.0	Removable reader and Extension plug 16 mm	Modular cylinder for armored doors with external electronic knob (free rotation), compatible with cylinders escutcheon, extension plug and pre-arranged for internal knob shaft D 8x16 mm	8MK36xxxxx65	<a href="#">→</a> 
8MK36D0xxxx55	Libra LE60 Smart 2.0	Removable reader and Extension plug 75 mm	Modular cylinder for armored doors with external electronic knob (free rotation), compatible with cylinders escutcheon, extension plug and pre-arranged for internal knob shaft D 8x75 mm	8MK36D0xxxx65	<a href="#">→</a> 
8MKxCxxxx55x	Libra LE60 Smart 2.0	Dummy-knob	Modular cylinder for armored doors with external electronic knob (free rotation) and knob-dummy on internal side	8MKxCxxxx65x	<a href="#">→</a> 

## Phased out products

Code	Product model	Title	Description	Substitution code	Go to page
<a href="#">8SKx90039xx55</a>	Libra LE60 Smart 2.0	Oval Australian	Oval Australian electronic cylinder with external electronic knob (free rotation)	8SKx90039xx65	<a href="#">→</a> 
<a href="#">8SKx20032xx55</a>	Libra LE60 Smart 2.0	Oval Scandinavian	Oval Scandinavian electronic cylinder with external electronic knob (free rotation)	8SKx20032xx65	<a href="#">→</a> 
<a href="#">5E1320156</a>	Stylos Smart 2.0	Credential reader with led	Credential reader with led	5E152315	<a href="#">→</a> 
<a href="#">5E1320456</a>	Stylos Smart 2.0	Credential reader with display and numeric keypad	Credential reader with display and numeric keypad	5E152325	<a href="#">→</a> 
<a href="#">5E1322106</a>	Stylos Smart 2.0	All-weather credential reader module	All-weather credential reader module	-	-
<a href="#">5E0555010</a>	Stylos Smart 2.0	Control unit for all-weather module	Control unit for all-weather module	-	-



**ISEO**<sup>®</sup>  
ULTIMATE ACCESS TECHNOLOGIES

**Iseo Serrature s.p.a.**  
Via San Girolamo, 13  
25055 Pisogne BS, Italy  
Tel. +39 0364 8821  
Fax +39 0364 882263  
[iseo@iseo.com](mailto:iseo@iseo.com)

**[iseo.com](http://iseo.com)**